



www.ajmostar.com

Surgical Instruments Catalogue



Micro Scissors—Diamond Coated Blades

The special diamond coated blades will increase the longevity of the cutting edge and improve the quality of the cut. Used to reduce wear on razor blades and industrial metal cutting tools, this coating is now being used in biomedical applications. Some studies have shown that even after double the normal usage of the cutting implement, no blade wear was detected.

- Hardness of coated surface resists wear and increases life of cutting edge
- Anti-reflective coating resists glare and assists in better view of surgical field
- Coating is corrosion resistant
- Reduced friction at cutting site decreases necrosis of surrounding tissue and bone

Micro Scissors, Stainless Steel

	503365	503364
Length	12 cm (4.75 in.)	12 cm (4.75 in.)
Blades	straight, 8 mm	curved, 8 mm
Tips	sharp, coated	sharp, coated



Vannas Scissors, Stainless Steel

	503371	503372
Length	9 cm (3.5 in.)	9 cm (3.5 in.)
Blades	straight, 6 mm	curved, 6 mm
Tips	3 mm cutting edge	3 mm cutting edge



McPherson-Vannas Scissors, Stainless Steel

	Standard	German	Standard	German
	14124	14124-G	501234	501234-G
Length	8 cm (3 in.)	8 cm (3 in.)	8 cm (3 in.)	8 cm (3 in.)
Blades	straight 5 mm	straight 5 mm	curved 5 mm	curved 5 mm
Tips	0.1 mm	0.1 mm	0.1 mm	0.1 mm



Standard and German versions may differ slightly in appearance.

These scissors have slightly rounded tips for blunt dissection.

McPherson-Vannas Scissors, Stainless Steel

	503215
Length	8 cm (3 in.)
Blades	straight, 3 mm
Tips	0.22 mm rounded tips



McPherson-Vannas Scissors, Stainless Steel

	503217
Length	8 cm (3 in.)
Blades	curved, 5 mm
Tips	0.3 mm rounded tips



McPherson-Vannas Scissors, Stainless Steel

	503216
Length	8 cm (3 in.)
Blades	angled on flat, 5 mm
Tips	0.5 mm rounded tips



McPherson-Vannas Scissors, Stainless Steel

	503214
Length	8 cm (3 in.)
Blades	45 angled to side, 5 mm
Tips	0.22 mm rounded tips



Ajmo Star Surgico

Showali(East.) P.O. Cantt Sialkot-51310, Pakistan

Tel: +92 52 4273146 Fax: +92 52 4298566 Email: info@ajmostar.com, sales@ajmostar.com



KIT-EXOTIC Exotic Animal Surgical Pack

KIT COMPONENTS ALSO AVAILABLE SEPARATELY

14192	Scissors, Surgical, 5.5"
14213	Instrument Case, 7.75" x 4.1" x 1.25"
14240	Retractor, ALM Self-Retaining
15908	Forceps, Dressing 12.5 cm straight
500216-G	Scissors, Iris, 11 cm, straight tungsten carbide blades
500227-G	Needle Holder, Olsen Hegar, with suture scissors

500236	Scalpel Handle #3, 13 cm
501244	Forceps, Micro Adson 12 cm
501291	Forceps, Mosquito 3.5" curved (2 in kit)
501705	Forceps, Hartman Mosquito 3.5" (2 in kit)



501315 Microsurgical Pack

KIT COMPONENTS ALSO AVAILABLE SEPARATELY

14098	Tweezers, Dumont #5, 11cm
14112	Scissors, Spring, 14 cm curved
14137	Needle Holder, Castroviejo 14 cm

14395	Scissors, Tenotomy, 10 cm straight
500253	Instrument Tray, autoclavable
500452	Forceps, Micro Hemostatic, 12.5 cm, curved (2 in kit)
501247	Knife Handle, Round Knurled
501250	Blades, Miniature Edge 12-pack
501313	Probe, 14 cm, stainless steel (not pictured)
501314	Retractor, Weitlaner, 10.8 cm



Ajmo Star Surgico

Showali(East.) P.O. Cantt Sialkot-51310, Pakistan

Tel: +92 52 4273146 Fax: +92 52 4298566 Email: info@ajmostar.com, sales@ajmostar.com

Canine Spay Pack

20 PIECES



503408 Canine Spay Pack

KIT COMPONENTS ALSO AVAILABLE SEPARATELY

- 500236** #3 Scalpel Handle
- 14226** Adson Brown Forceps, 4 3/4"
- 501324** Aliss Tissue Forceps, 6", 4x5
- 501217** Dressing Forceps, 5.5"
- V503381** Groove Director

- V503380** Jones Towel Clamp, 3.5" (3 in kit)
- 501288** Kelly Forceps, 5.5", curved (2 in kit)
- 501241** Kelly Forceps, 5.5", straight (2 in kit)
- 501751** Mayo Scissors, 6 3/4", straight
- V503382** Mayo-Hegar Needle Holder, 6 3/4"
- 15921** Mosquito Forceps, 5", curved (2 in kit)
- 15920** Mosquito Forceps, 5", straight (2 in kit)
- 501998** Olsen-Hegar Castroviejo Needle Holder, 6.5"
- 501289** Snook Hook, 8"

Feline Spay Pack



18 PIECES

503409 Feline Spay Pack

KIT COMPONENTS ALSO AVAILABLE SEPARATELY

- 500236** Scalpel Handle #3, 13 cm
- 14226** Adson Brown Forceps, 4 3/4"
- 501217** Dressing Forceps, 5.5"
- V503380** Jones Towel Clamp, 3.5" (3 in kit)
- 501288** Kelly Forceps, 5.5", curved (2 in kit)
- 501241** Kelly Forceps, 5.5", straight (2 in kit)

- V503382** Mayo-Hegar Needle Holder, 6 3/4"
- 501751** Mayo Scissors, 6 3/4", straight
- 15921** Mosquito Forceps, 5", curved (2 in kit)
- 15920** Mosquito Forceps, 5", straight (2 in kit)
- 501998** Olsen-Hegar Needle Holder, 6.5"
- 501289** Snook Hook 8"

Surgical Instruments - www.ajmostar.com



Ajmo Star Surgico

Showali(East.) P.O. Cantt Sialkot-51310, Pakistan

Tel: +92 52 4273146 Fax: +92 52 4298566 Email: info@ajmostar.com, sales@ajmostar.com



General Surgery Basic Pack

20 PIECES

503407 General Surgery Basic Pack

KIT COMPONENTS ALSO AVAILABLE SEPARATELY

500236 #3 Scalpel Handle
501700 Backhaus Towel Clamps, 5 1/4" (4 in kit)
500177 Brown-Adson Forceps, 7x7 teeth
501241 Kelly Hemostatic Forceps, 5.5", straight (2 in kit)
501751 Mayo Scissors, 6 3/4", straight
501253 Metzenbaum Scissors, curved, 7"
15921 Mosquito Hemostatic Forceps 5", curved (3 in kit)

500023 Olsen Hegar Needle Holder, 5 1/2"
501243 Rochester Carmalt Forceps, 6 1/4", curved (4 in kit)
501289 Snook Ovariectomy
503392 Sterilization case



Suture Removal Pack

15 PIECES

503410 Suture Removal Pack

KIT COMPONENTS ALSO AVAILABLE SEPARATELY

500178 Adson Tissue Forceps, 1x2, teeth, 4 3/4"
501320 Backhaus Towel Clamp, 3.5" (4 in kit)
501291 Hartman Forceps, curved, 3.5" (2 in kit)
15921 Halsted Mosquito Forceps, curved, 5" (2 in kit)
501752 Mayo Scissors, 6 3/4", curved

501745 Metzenbaum Scissors, curved
500227 Olsen Hager Needle Holder, 5.5", straight
500236 Scalpel Handle #3
501704 Stitch Scissors, 5.5"
15918 Tissue Forceps, 1x2 teeth, 5.5"

Surgical Instruments - www.ajmostar.com



Ajmo Star Surgico Showali(East.) P.O. Cantt Sialkot-51310, Pakistan

Tel: +92 52 4273146 Fax: +92 52 4298566 Email: info@ajmostar.com, sales@ajmostar.com

Mini Plates

1.5mm Straight Plate



503614 Screw size: 1.5 mm cortex, 100mm length, 20 holes

Thickness: 0.9 mm
Width: 3.8 mm
Hole Spacing: 5 mm

1.5mm T-Plates



Thickness: 0.9 mm
Width: 3.8 mm
Length: 49 mm

503615 Screw size: 1.5mm cortex, 3 holes in head, 9 holes in shaft

503616 Screw size: 1.5mm cortex, 4 holes in head, 9 holes in shaft

2.0mm Straight Plates



503617 Screw size: 2.0mm cortex, 17mm length, 3 holes

503618 Screw size: 2.0mm cortex, 23mm length, 4 holes

503619 Screw size: 2.0mm cortex, 29mm length, 5 holes

503688 Screw size: 2.0mm cortex, 35mm length, 6 holes

503621 Screw size: 2.0mm cortex, 100mm length, 20 holes



FOR 20 HOLE PLATE
Thickness: 1.2 mm
Width: 5 mm
Hole Spacing: 5 mm

2.0mm L-Plates



503574 Screw size: 2.0mm cortex, 2 holes in shaft, Oblique Right

503575 Screw size: 2.0mm cortex, 2 holes in shaft, Oblique Left

503576 Screw size: 2.0mm cortex, 2 holes in shaft, Right

503577 Screw size: 2.0mm cortex, 2 holes in shaft, Left



Thickness: 0.9 mm
Width: 5 mm
Hole Spacing: 6 mm

2.7mm Small Compression Plates



Thickness: 2 mm (2-6 hole)
2.5 mm (7-12 hole)
Width: 8 mm

503578 Screw size: 2.7mm cortex, 20mm length, 2 holes

503579 Screw size: 2.7mm cortex, 26mm length, 2 holes

503580 Screw size: 2.7mm cortex, 29mm length, 4 holes

503581 Screw size: 2.7mm cortex, 35mm length, 5 holes

503670 Screw size: 2.7mm cortex, 52mm length, 6 holes

503671 Screw size: 2.7mm cortex, 60mm length, 7 holes

503661 Screw size: 2.7mm cortex, 68mm length, 8 holes

503662 Screw size: 2.7mm cortex, 76mm length, 9 holes

503663 Screw size: 2.7mm cortex, 84mm length, 10 holes

503664 Screw size: 2.7mm cortex, 100mm length, 12 holes

2.7mm T- Plates



Thickness: 1.2 mm
Width: 7 mm
Hole Spacing: 8 mm
Length: 32 mm

503665 Screw size: 2.7mm cortex, 32mm length, 3 holes



Ajmo Star Surgico

Showali(East.) P.O. Cantt Sialkot-51310, Pakistan

Tel: +92 52 4273146 Fax: +92 52 4298566 Email: info@ajmostar.com, sales@ajmostar.com

2.0 mm Cortex Screws – Hexagonal or Cruciate Head

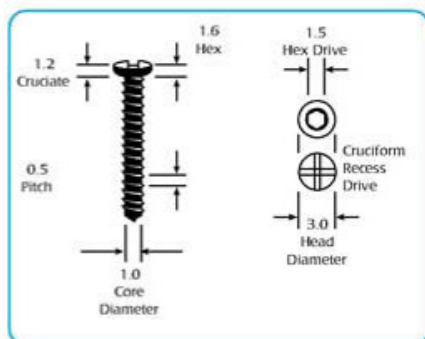

Thread diameter	2.0 mm
Core diameter	1.3 mm
Thread pitch	0.6 mm
Hex screw head diameter	4.0 mm
Cruciate screw head diameter	3.4 mm

Hex Socket

503470	Cortex screw, hex socket, 6 mm
503471	Cortex screw, hex socket, 8 mm
503472	Cortex screw, hex socket, 10 mm
503473	Cortex screw, hex socket, 12 mm
503474	Cortex screw, hex socket, 14 mm
503475	Cortex screw, hex socket, 16 mm
503476	Cortex screw, hex socket, 18 mm
503477	Cortex screw, hex socket, 20mm
503478	Cortex screw, hex socket, 22mm
503479	Cortex screw, hex socket, 24mm
503480	Cortex screw, hex socket, 26mm
503481	Cortex screw, hex socket, 28mm
503482	Cortex screw, hex socket, 30mm
503483	Cortex screw, hex socket, 32mm

Cruciated Socket

503484	Cortex screw, cruciated socket, 6mm
503485	Cortex screw, cruciated socket, 8mm
503486	Cortex screw, cruciated socket, 10mm
503487	Cortex screw, cruciated socket, 12mm
503488	Cortex screw, cruciated socket, 14mm
503489	Cortex screw, cruciated socket, 16mm
503490	Cortex screw, cruciated socket, 18mm
503491	Cortex screw, cruciated socket, 20mm
503492	Cortex screw, cruciated socket, 22mm
503493	Cortex screw, cruciated socket, 24mm
503494	Cortex screw, cruciated socket, 26mm
503495	Cortex screw, cruciated socket, 28mm
503496	Cortex screw, cruciated socket, 30mm
503497	Cortex screw, cruciated socket, 32mm

2.7 mm Cortex Screws

Used in the metacarpal and metatarsal bones and also in certain indications in the radius and ulna.

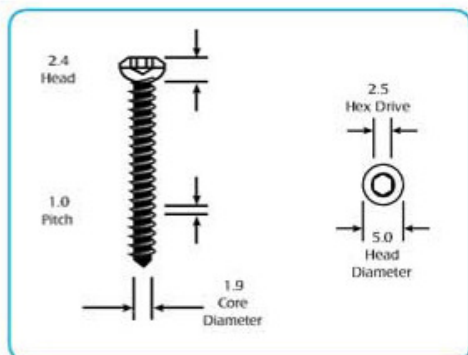

Thread diameter	2.7 mm
Core diameter	1.9 mm
Thread pitch	1.0 mm
Screw head diameter	5.0 mm

Cortex Screws

503498	Cortex screw, 6mm, hex socket
503499	Cortex screw, 8mm, hex socket
503647	Cortex screw, 10mm, hex socket
503648	Cortex screw, 12mm, hex socket
503649	Cortex screw, 14mm, hex socket
503650	Cortex screw, 16mm, hex socket
503651	Cortex screw, 18mm, hex socket
503652	Cortex screw, 20mm, hex socket
503653	Cortex screw, 22mm, hex socket
503654	Cortex screw, 24mm, hex socket
503655	Cortex screw, 26mm, hex socket
503656	Cortex screw, 28mm, hex socket
503657	Cortex screw, 30mm, hex socket
503658	Cortex screw, 32mm, hex socket
503635	Cortex screw, 34mm, hex socket
503636	Cortex screw, 36mm, hex socket
503637	Cortex screw, 38mm, hex socket
503638	Cortex screw, 40mm, hex socket



Ajmo Star Surgico Showali(East.) P.O. Cantt Sialkot-51310, Pakistan

Tel: +92 52 4273146 Fax: +92 52 4298566 Email: info@ajmostar.com, sales@ajmostar.com

Hoof Knife

Narrow, right side

503436



Hoof Knife

Narrow, left side, Bakelite handle

503437



Depth Gauge

For 2.7-4.0 mm screws

503430



Bending Plate

For 2.7 mm, 3.5 (2 units, R/L)

503611



Screws and Plates

1.5 mm Cortex Screws — Hexagonal or Cruciate Head

Used to fix fracture fragments in the phalanges, metacarpals and small bones in the foot. These screws may be used independently as lag screws or through a plate.

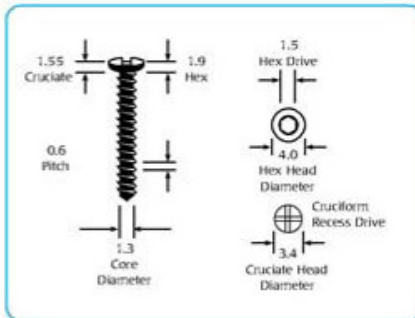

Thread diameter	1.5 mm
Core diameter	1.0 mm
Thread pitch	0.5 mm
Screw head diameter	3.0 mm

Hex Socket

503448	Cortex screw, hex socket, 6mm
503449	Cortex screw, hex socket, 7mm
503450	Cortex screw, hex socket, 8mm
503451	Cortex screw, hex socket, 9mm
503452	Cortex screw, hex socket, 10mm
503453	Cortex screw, hex socket, 11mm
503454	Cortex screw, hex socket, 12mm
503455	Cortex screw, hex socket, 14mm
503456	Cortex screw, hex socket, 16mm
503457	Cortex screw, hex socket, 18mm
503458	Cortex screw, hex socket, 20mm

Cruciated Socket

503459	Cortex screw, cruciated socket, 6mm
503460	Cortex screw, cruciated socket, 7mm
503461	Cortex screw, cruciated socket, 8mm
503462	Cortex screw, cruciated socket, 9mm
503463	Cortex screw, cruciated socket, 10mm
503464	Cortex screw, cruciated socket, 11mm
503465	Cortex screw, cruciated socket, 12mm
503466	Cortex screw, cruciated socket, 14mm
503467	Cortex screw, cruciated socket, 16mm
503468	Cortex screw, cruciated socket, 18mm
503469	Cortex screw, cruciated socket, 20mm



Ajmo Star Surgico

Showali(East.) P.O. Cantt Sialkot-51310, Pakistan

Tel: +92 52 4273146 Fax: +92 52 4298566 Email: info@ajmostar.com, sales@ajmostar.com

Pin Removal Forceps

Parallel action pliers, useful for bending, holding and cutting small pins and wires. Stainless steel
Length: 7.5 in. (19 cm)

503687



Bone Plate Holder

Maintain plate position through a hole in the plate. The ball behind the point of each jaw tip locates in bone plate screw hole.

Length: 6 in. (15 cm)

503677



Bone Holding Forceps

Wide jaws take hold of a good portion over the fracture line. Bone screws may be inserted through the center of either jaw. Stainless steel.

Length: 6 in. (15 cm)

503678

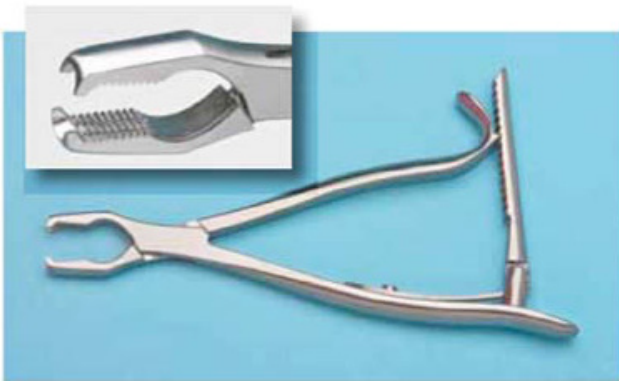

Baby Kerns Bone Forceps

6 in. (15 cm) **503679**

8 in. (20 cm) **503680**



Excision Arthroplasty Rasp

For easy removal of bone spurs or rough edges in a femoral head excision. Rasp cuts only on backward stroke. Stainless steel.

Length: 6.5 in. (17 cm)

503681

Foman Bone Rasp

Double-ended rasp with convex and flat files. Teeth are coarse on one side and fine on the other. Length: 8.25 in. (21 cm)

503683



Putti Bone Rasp

Double-ended rasp with round and half-round tapered, curved ends. Length: 12 in. (30 cm)

503750



Putti Bone Rasp

Double-ended rasp with flat ends—one with the flat surface curved, the other with a curved edge. Length: 8.5 in. (25 cm)

503751



Ajmo Star Surgico

Showali(East.) P.O. Cantt Sialkot-51310, Pakistan

Tel: +92 52 4273146 Fax: +92 52 4298566 Email: info@ajmostar.com, sales@ajmostar.com

Plate Bender

Double-sided rollers for 3.5 mm narrow, 3.5 mm broad, and 4.5 mm narrow plates. Stainless steel with aluminum handles. Length: 15 in. (38 cm)

503676



Pin Cutter

For cutting intramedullary pins and customizing bone plates. Stainless steel with tungsten carbide inserts. Cuts pins up to 1/4-in. (6.4mm). Length: 19 in. (48 cm)

503686



K-wire Cutter

Tungsten carbide inserts. Cuts wire up to (2.2mm).

503684 Length: 8 in.

503685 Length: 9 in.



Ecklin-Duckbill Rongeur

Double-action, 3mm bite.

Length: 8.5 in. (21.6 cm)

503682



Ajmo Star Surgico

Showali(East.) P.O. Cantt Sialkot-51310, Pakistan

Tel: +92 52 4273146 Fax: +92 52 4298566 Email: info@ajmostar.com, sales@ajmostar.com

Orthopedic Instruments

503428
 Verbrugge Bone Holding Forceps, 20 cm, for 3.5 and 4.5 mm plates

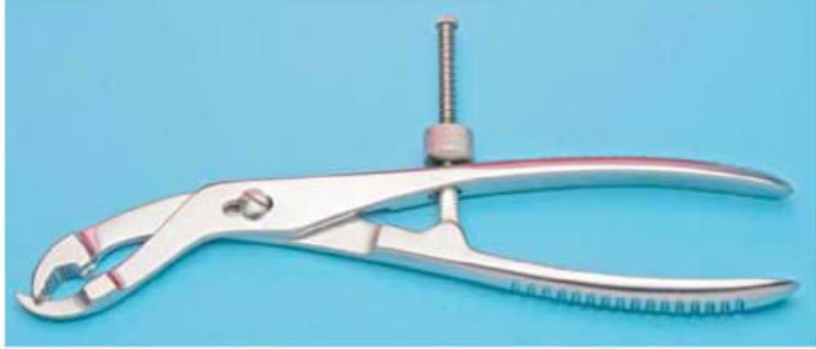

503689
 Volkman curette #3, oval cutting surface, 17 cm long



503689
 Volkman curette #3, oval cutting surface, 17 cm long



503429
 Schroeder curette (3 mm x 5 mm), lesions, oval cutting surface, 22 cm long



503432
 Drill Guide handle for 2.0 mm plates, uses 1.5 pilot hole drill bit



503431
 Load/Neutral Drill Guide for 2.7 mm plates, uses 2.0 pilot hole drill bit



503434
 Drill Guide handle for 3.5 mm plates, uses 2.5 pilot hole drill bit



Screwdriver
 For 0.7, 3.0, 3.5, 4.0 mm flat-head screws

503688 Screwdriver, 15 cm long.
503433 Screwdriver, 20 cm long.
503596 Screwdriver, 25 cm long.



Close-up

503435
 Hoof Knife, wide blade, wood handle, left side



Surgical Instruments - www.ajmostar.com



Ajmo Star Surgico

Showali(East.) P.O. Cantt Sialkot-51310, Pakistan

Tel: +92 52 4273146 Fax: +92 52 4298566 Email: info@ajmostar.com, sales@ajmostar.com

Veterinary Periodontal Surgery, Basic Set-up

KIT COMPONENTS ALSO AVAILABLE SEPARATELY

503413	Mirror, Cone Socket (<i>pkg of 12</i>)
503414	Double End Explorer
503415	Periodontal Probe
500236	Scalpel Handle #3
503417	1 Ochsensbein Chisel
503418	2 Ochsensbein Chisel
503419	Kirkland Gum Knife
503420	Orban Scaler
503422	Gracey Curettes #11-12
503424	Gracey Curettes #13-14
503406	Periosteal elevator, double-ended
503423	Scaler, double-ended
503421	Jacquette Scaler #1SSE



503447 Veterinary Periodontal Surgery, Basic Set-up Pack



Ajmo Star Surgico

Showali(East.) P.O. Cantt Sialkot-51310, Pakistan

Tel: +92 52 4273146 Fax: +92 52 4298566 Email: info@ajmostar.com, sales@ajmostar.com

Veterinary Extraction, Basic Set-up Pack



9 PIECES

503446 Veterinary Extraction, Basic Set-up Pack

KIT COMPONENTS ALSO AVAILABLE SEPARATELY

500236	#3 Scalpel Handle
503406	Molt Peristal Elevator, double-ended
503425	Extracting Universal Forceps, #24
503426	Extracting Universal Forceps #150 (Cryer)

503246	La Grange Scissors
501989	Olsen Hager Needle Holder with Scissors
500177	Brown - Adson, 7x7 teeth
500380	Suture Scissors
503427	Root tip Elevator

Rodent/Rabbit Dental Starter Pack



8 PIECES

503445 Rodent/Rabbit Dental Starter Pack

KIT COMPONENTS ALSO AVAILABLE SEPARATELY

503438	Rodent Cheek Dilator, large
503439	Rodent Cheek Dilator, small
503440	Rodent Dental Spatula
503441	Rodent Molar Cutter
503442	Rodent Molar Extractor
503443	Rodent Mouth Gag
503444	Rodent Tooth Rasp
14213	Sterilization Tray 197 x 107 x 32m



Ajmo Star Surgico Showali(East.) P.O. Cantt Sialkot-51310, Pakistan

Tel: +92 52 4273146 Fax: +92 52 4298566 Email: info@ajmostar.com, sales@ajmostar.com



Crane Elevator - right
15 cm (5.9 in.) long
503404



Crane Elevator - left
15 cm (5.9 in.) long
503403



Albright Forceps, Stainless Steel
503395 Round tip (pictured), 16 cm (6.3 in.) long
503396 Sharp tip, 16 cm (6.3 in.) long

Rodent Dental Spatula, Stainless Steel
16.5 cm (6.5 in.) long
503440



Rodent Cheek Dilator, large, Stainless Steel
8.5 cm (3.3 in.) long
503438

Rodent Cheek Dilator, small, Stainless Steel
5.6 cm (2.2 in.) long
503439



Rodent Tooth Rasp, Stainless Steel
17.5 cm (6.9 in.) long
503444

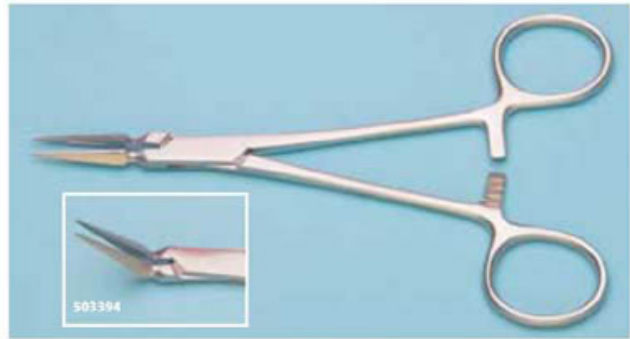

Stieglitz Forceps
503393 (straight)

15 cm (5.9 in.) long
503394 (45° angled tip) ...
15 cm (5.9 in.) long, serrated



Periosteal Elevator, Stainless Steel
17 cm (6.7 in.) long
Double ended: rounded blade, 5mm wide and slightly curved; spear point, 3mm wide
503406



Rodent Molar Cutter, Stainless Steel
17.5 cm (6.9 in.) long
503441



Rodent Molar Extractor, Stainless Steel
15 cm (5.9 in.) long
503442



Rodent Mouth Gag, Stainless Steel
11.5 cm (4.5 in.) long
503443



Ajmo Star Surgico Showali(East.) P.O. Cantt Sialkot-51310, Pakistan

Tel: +92 52 4273146 Fax: +92 52 4298566 Email: info@ajmostar.com, sales@ajmostar.com

Veterinary Dental Instruments



Universal Plier, Stainless Steel

15 cm (5.9 in.) long

503405.....



Extracting Universal Forceps #24, Stainless Steel

17.8 cm (7 in.) long

503425.....



Extracting Forceps #65, Stainless Steel

19 cm (7.5 in.) long

503398.....



Root Elevator #27 left, Stainless Steel

15 cm (5.9 in.) long

503400.....



Extracting Forceps #76N, Stainless Steel

19 cm (7.5 in.) long

503399.....



Root Elevator #28 right, Stainless Steel

15 cm (5.9 in.) long

503401.....



Extracting Forceps, Stainless Steel

14.5 cm (5.7 in.) long

503397 (small breed).....



Root Elevator #301, Stainless Steel

15 cm (5.9 in.) long

503402.....



Extracting Universal Forceps #150 (Cryer Forceps),

Stainless Steel

17.8 cm (7 in.) long

503426.....



Root Tip Elevator, Stainless Steel

14.6 cm (5.75 in.) long

503427.....

Surgical Instruments - www.ajmostar.com



Ajmo Star Surgico

Showali(East.) P.O. Cantt Sialkot-51310, Pakistan

Tel: +92 52 4273146 Fax: +92 52 4298566 Email: info@ajmostar.com, sales@ajmostar.com



503711-12

503711-12 Lister Bandage Scissors, 14 cm (Pack of 12)
503712-12 Lister Bandage Scissors, 9 cm (Pack of 12)



503716-12

Tip Profiles:

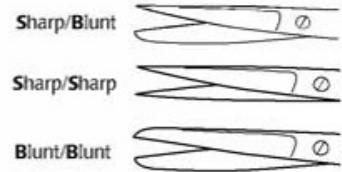

503713-12 Operating Scissors, 14 cm, b/b, curved (Pack of 12)
503714-12 Operating Scissors, 14 cm, s/b, straight (Pack of 12)
503715-12 Operating Scissors, 14 cm, s/b, curved (Pack of 12)
503716-12 Operating Scissors, 14 cm, s/s, straight (Pack of 12)
503717-12 Operating Scissors, 14 cm, b/b, straight (Pack of 12)
503718-12 Operating Scissors, 14 cm, s/b, curved (Pack of 12)
503727-12 Operating Scissors, 14 cm, s/s, curved (Pack of 12)



Ajmo Star Surgico

Showali(East.) P.O. Cantt Sialkot-51310, Pakistan

Tel: +92 52 4273146 Fax: +92 52 4298566 Email: info@ajmostar.com, sales@ajmostar.com

503732-12



503732-12 Mayo Hegar Needle Holder, 7 in., straight (Pack of 12)

503733-12 Mayo Hegar Needle Holder, 6 in., straight (Pack of 12)

503707-12



503706-12 Tuff Cut Scissors, plastic handles, 18 cm (Pack of 12)

503707-12 Tuff Cut Scissors, plastic handles, 14.5 cm (Pack of 12)

503708-12



503708-12 Iris Scissors, 11.5 cm, straight (Pack of 12)

503709-12 Iris Scissors, 11.5 cm, curved (Pack of 12)



Ajmo Star Surgico Showali(East.) P.O. Cantt Sialkot-51310, Pakistan

Tel: +92 52 4273146 Fax: +92 52 4298566 Email: info@ajmostar.com, sales@ajmostar.com

503725-12



503725-12 Crile-Wood Needle Holder, 7 in., straight, (Pack of 12)

503726-12 Crile-Wood Needle Holder, 6 in., straight, (Pack of 12)

503730-12 Derf Needle Holder, 5 in., straight, (Pack of 12)



503731-12 Webster Needle Holder, 5 in., straight, (Pack of 12)



Ajmo Star Surgico Showali(East.) P.O. Cantt Sialkot-51310, Pakistan

Tel: +92 52 4273146 Fax: +92 52 4298566 Email: info@ajmostar.com, sales@ajmostar.com

503722-12



503721-12 Iris Forceps, straight, serrated tips, 10 cm (Pack of 12)

503122-12 Iris Forceps, curved, serrated tips, 10 cm (Pack of 12)

503721-12



503723-12



503723-12 Halstead Mosquito Forceps, 12.5 cm, straight (Pack of 12)

503724-12 Halstead Mosquito Forceps, 12.5 cm, curved (Pack of 12)

503729-12



503728-12 Hartman Mosquito Forceps, 9 cm, straight (Pack of 12)

503729-12 Hartman Mosquito Forceps, 9 cm, curved (Pack of 12)



Ajmo Star Surgico Showali(East.) P.O. Cantt Sialkot-51310, Pakistan

Tel: +92 52 4273146 Fax: +92 52 4298566 Email: info@ajmostar.com, sales@ajmostar.com



503704-12 Foester Sponge Forceps, 9.5-in., straight, serrated (Pack of 12)
All sales are final on economy instrument packs.



503719-12

503719
Tip Profile:

503720
Tip Profile:

503719-12 Adson Forceps, straight, serrated tips, 12 cm (Pack of 12)
503720-12 Adson Forceps, straight, 1x2 teeth, 12 cm (Pack of 12)
All sales are final on economy instrument packs.



503710-12 Bozeman Forceps, curved, 25 cm (Pack of 12)
All sales are final on economy instrument packs.



Ajmo Star Surgico Showali(East.) P.O. Cantt Sialkot-51310, Pakistan

Tel: +92 52 4273146 Fax: +92 52 4298566 Email: info@ajmostar.com, sales@ajmostar.com

Economy Surgical Instruments

Chrome-finish single-use stainless steel

Cheaper by the dozen – no need to resterilize

503701-12 Crile Forceps, curved, 14 cm (Pack of 12)
503700-12 Crile Forceps, straight, 14 cm (Pack of 12)

All sales are final on economy instrument packs.



503701-12



503702-12

503702-12 Kelly Forceps, 14 cm, straight (Pack of 12)
503703-12 Kelly Forceps, 14 cm, curved (Pack of 12)

All sales are final on economy instrument packs.



503705-12 Foester Sponge Forceps, 9.5-in., curved, serrated (Pack of 12)



Ajmo Star Surgico Showali(East.) P.O. Cantt Sialkot-51310, Pakistan

Tel: +92 52 4273146 Fax: +92 52 4298566 Email: info@ajmostar.com, sales@ajmostar.com

Mouse Vessel Cannulation Kit

Kit includes:

- Vessel Cannulation Forceps
- Vannas Scissors
- Fine Serrated Forceps
- Dumont #5 Tweezers
- Alm Retractor
- MicroFil 28 ga.

Order Number
501895

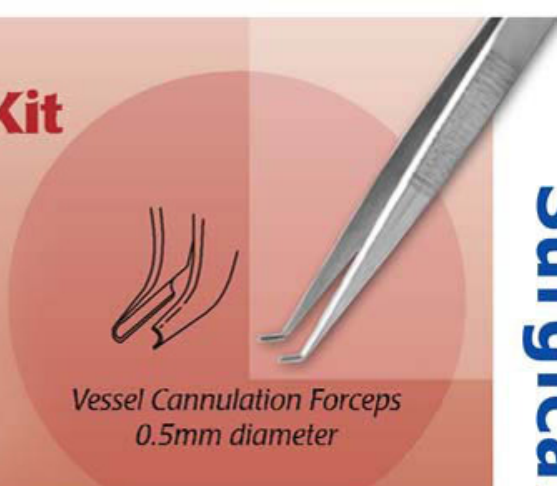

Vessel Cannulation Forceps
0.5mm diameter

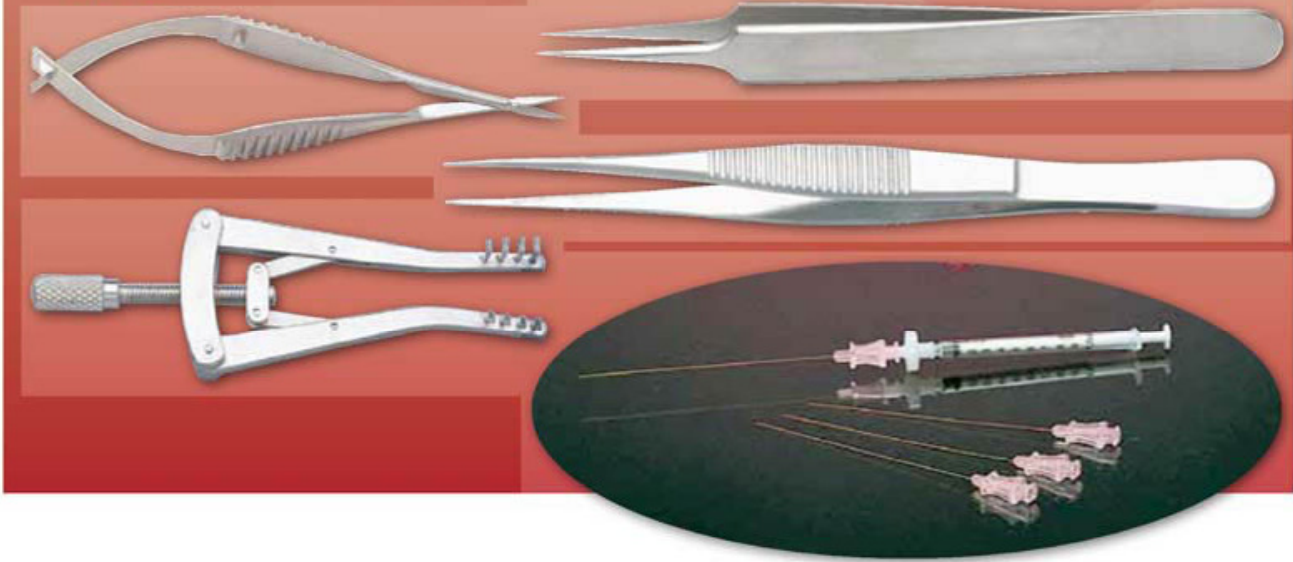

Vessel Cannulation Forceps for 0.5mm diameter cannula, 10 cm (4 in.) long
500377.....



1:1

Vessel Cannulation forceps for 1.0 mm diameter cannula, 10 cm (4 in.) long
500453.....

Dumont Vessel Cannulation Forceps

Length: 13cm
Cannulation: 0.5mm OD

503374.....



1:1



Dumont Vessel Cannulation Forceps

Length: 13cm
Cannulation: 0.35mm OD

503373.....



Dumont Vessel Cannulation Forceps

Length: 13cm
Cannulation: 1.0mm OD

503375.....

Vessel cannulation forceps are designed to insert small catheters into vessels. The small hollow jaws of the forceps ensure a secure insertion without damaging the fine tubes.



Ajmo Star Surgico Showali(East.) P.O. Cantt Sialkot-51310, Pakistan

Tel: +92 52 4273146 Fax: +92 52 4298566 Email: info@ajmostar.com, sales@ajmostar.com

Surgical Instruments - www.ajmostar.com

Physiology Kit I

SuperCut Tenotomy Scissors curved (#14396)
Rongeur 3mm jaw (#14091)
Utility Scissors (#501322)
Operating Scissors straight Sharp/Blunt (#14192)
Dumont Tweezer #5 (#14098)
Flat Jaw Tweezers (#501303)
Probe 1.0 mm diameter, blunt (#501313)
Order Number: KIT-PHYSIO-I



Mouse Kit

Dumont #5 (#14098)
Vannas Scissors (#14003)
Iris Forceps, curved, serrated (#15915)
Dissecting Scissors, straight 10cm (#14393)
Wire Retractor (#14130)
Needle Holder (#14109)
Blunt Probe, 1.0 mm diameter (#501313)
Order Number: MOUSEKIT



Now includes storage case!

Physiology Kit II

Vannas Scissors (#14003)
SuperCut Iris Scissors straight (#14218)
Rongeur 1.3mm jaw (#14292)
Utility Scissors (#501322)
Probe 1.0 mm diameter, blunt (#501313)
Operating Scissors straight Sharp/Blunt (#14192)
Dumont Tweezer #5 (#14098)
Stevenson Retractor (#14131)
Iris Forceps curved (#15915)
Adson Forceps 1x2 teeth (#500092)
Olsen-Hegar Needle holder (#500227)
Order Number: PHYSIO-II

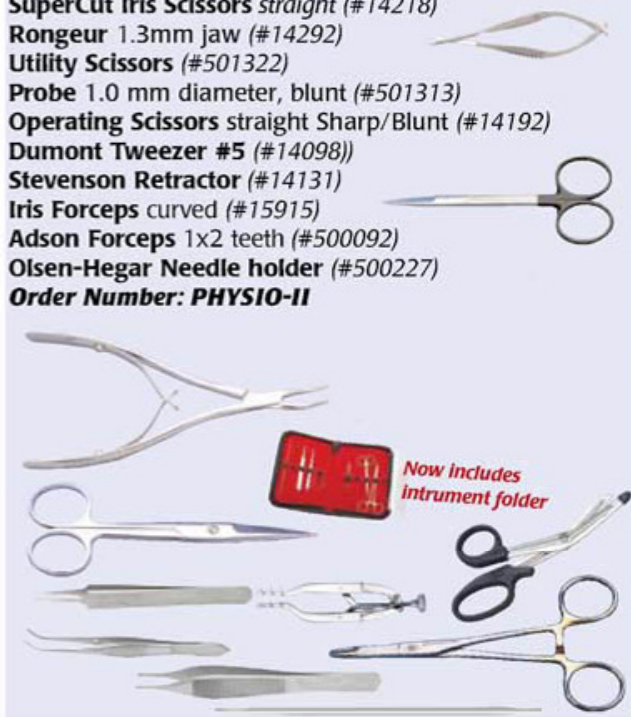

Now includes
instrument folder

Rat Kit

Dumont #5 (#14098)
Vannas Scissors (#14124)
Iris Forceps, serrated (#15915)
SuperCut Iris Scissors, straight 10cm (#14218)
Alm Retractor (#14240)
Needle Holder (#14110)
Blunt Probe, 1.0 mm diameter (#501313)
Order Number: RATKIT

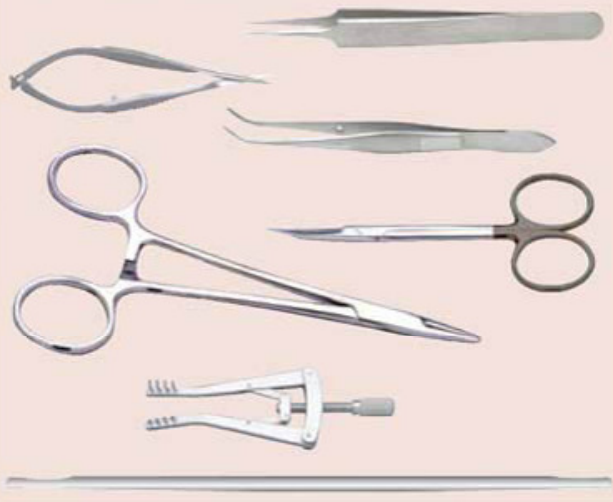

Surgical Instruments - www.ajmostar.com



Ajmo Star Surgico

Showali(East.) P.O. Cantt Sialkot-51310, Pakistan

Tel: +92 52 4273146 Fax: +92 52 4298566 Email: info@ajmostar.com, sales@ajmostar.com



Wells Enucliation Spoon
Stainless steel
14 cm (5.5 in.) long
503762

1:1

- 503754** Schepens Scleral Depressor #8 (small)
- 503755** Schepens Scleral Depressor #10 (medium)
- 503756** Schepens Scleral Depressor #12 (large)



1:1

Bunge Evisceration Spoon
Stainless steel
13.5 cm (5.3 in.) long
503761



1:1

Paton Spatula and Spoon
Stainless steel
14 cm (5.5 in.) long
504022



1:1

Culler Lens Spoon
Stainless steel
13 cm (5.1 in.) long
503760



1:1

Halveston Tissue Retractor
Stainless steel, thin curved blade, 7mm
12.5 cm (4.9 in.) long
503759



1:1

Engel Tenotomy Hook
Stainless steel
Double prong, sharp tips
13 cm (5.1 in.) long
504021



1:1

Knapp Lacrimal Retractor
Stainless steel
Blunt tips, 13.5 cm (5.3 in.)
503758



1:1

Schepens Orbital Retractor
Stainless Steel
14.5 cm (5.7 in.)
503757



1:1



Ajmo Star Surgico Showali(East.) P.O. Cantt Sialkot-51310, Pakistan

Tel: +92 52 4273146 Fax: +92 52 4298566 Email: info@ajmostar.com, sales@ajmostar.com

Graefe Hook
503221



Dura Hook
Sharp, 15 cm
503322



1:1

Meyhoefer Curette
14cm (5.5 in.), 1.5mm diameter
Standard 501773



1:1

Tyrell Hook, sharp, 13 cm (5 in.) long
Standard 14136



1:1

Wecker Spatula
14cm (5.5 in.), 3mm wide blade
Standard 501772



1:1

Dura Dissector
20 cm
503336



Not shown actual size

Scleral Depressor
Double-ended with pocket clip, 13 cm (5 in.)
Stainless steel
503353



1:1

Brain Spatula
22 cm
503338



Not shown actual size

Castroviejo Caliper
75 mm (3 in.) long
20 mm scale
501200



1:1



Vascular Measuring Ruler
503211

1:1



Ajmo Star Surgico

Showali(East.) P.O. Cantt Sialkot-51310, Pakistan

Tel: +92 52 4273146 Fax: +92 52 4298566 Email: info@ajmostar.com, sales@ajmostar.com

Hooks and Probes

Tungsten Dissection Probes

● Used for separating cells ● Made of pure tungsten, a hard and biocompatible metal ● Less than one micron in diameter ● Stronger and more durable than glass probes ● 50 mm long (10 pieces per package)

Tip Profile A



Tip Profile A

- 500133** Tungsten Dissecting Probe, 0.125mm diameter rod
- 500134** Tungsten Dissecting Probe, 0.25mm diameter rod
- 500135** Tungsten Dissecting Probe, 0.5mm diameter rod

Tip Profile B



Tip Profile B

- 501316** Tungsten Dissecting Probe, 0.125mm diameter rod
- 501317** Tungsten Dissecting Probe, 0.25mm diameter rod
- 501318** Tungsten Dissecting Probe, 0.5mm diameter rod

Handle for Probe, stainless steel

11 cm (4.3 in.) long **500448**

7 cm (2.75 in.) long **501301**



1:1

Probe

Stainless steel, 14cm (5.5 in.), 1.0 mm diameter

501313



500458 Straight Dissecting Needles, 14 cm (5.5 in.) long, 12/box



500460 Curved Dissecting Needles, 14 cm (5.5 in.) long, 12/box

Groove Director

15 cm (6 in.) long

V503381



Perforated Spoon

Length: 15 cm (5.9 in.), bowl diameter 20 mm (0.8 in.)

501997



Ajmo Star Surgico

Showali(East.) P.O. Cantt Sialkot-51310, Pakistan

Tel: +92 52 4273146 Fax: +92 52 4298566 Email: info@ajmostar.com, sales@ajmostar.com



Bone Cutter
one serrated blade, 11 cm (4.3 in.) long,
9 mm blades
501269



1:1



Cuticle nipper
11 cm (4.3 in.) long, angle, ring handles
Standard **500137**
German **500137-G**

1:1



Nail nippers
14 cm (5.5 in.) long, concave jaws, double
spring
Standard **500362**....
German **500362-G** .

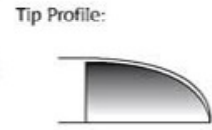

1:1



Stainless Steel Wire Cutter
15 cm (6 in.) long, Tungsten Carbide blades
503674



1:1



Liston Bone Cutting Forceps
19 cm (7.5 in.) long, straight **500358**
14 cm long, straight **500462**



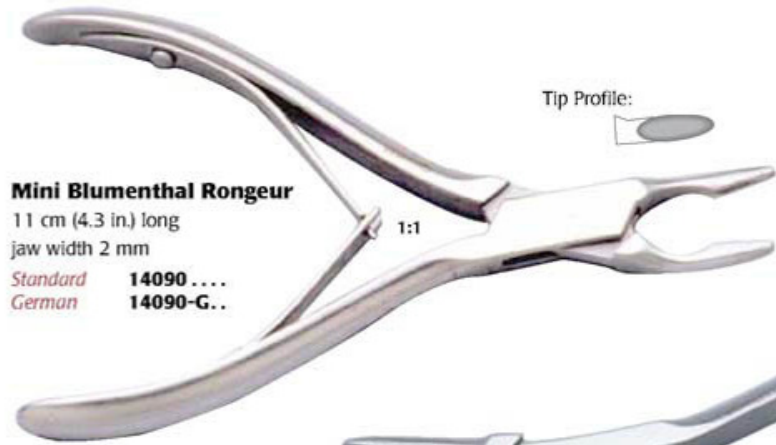

Mini Blumenthal Rongeur
 11 cm (4.3 in.) long
 jaw width 2 mm
 Standard 14090
 German 14090-G..

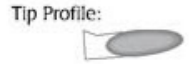

1:1



Friedman Rongeur
 13 cm (5 in.) long
 jaw width 2.5 mm
 Standard 14089
 German 14089-G . . .
 15 cm long (6 in.)
 Standard 503295 . . .



1:1



Blumenthal Rongeur
 15 cm (6 in.) long
 jaw width 3 mm
 Standard 14091
 German 14091-G..



1:1

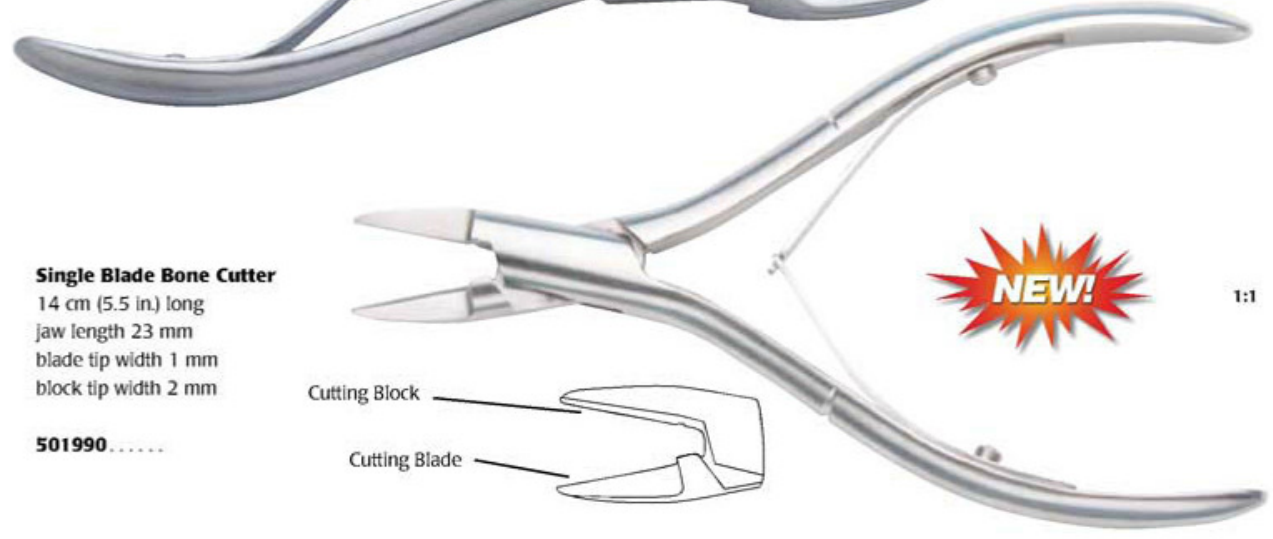

Single Blade Bone Cutter
 14 cm (5.5 in.) long
 jaw length 23 mm
 blade tip width 1 mm
 block tip width 2 mm

501990

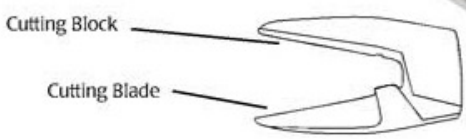

1:1

The Corneoscleral punch is excellent for removing the skull of a small animal without damaging the brain or spinal cord. The lower jaw of the punch is a flat plate which can be inserted into the skull with much less damage to the brain than a rongeur.

- 500079 Corneoscleral Punch , 8 cm (3 in.) long, 2 mm wide
- 500143 Corneoscleral Punch, 8 cm (3 in.) long, 1.5 mm wide

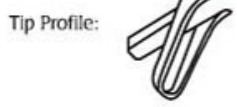

1:1



Ajmo Star Surgico Showali(East.) P.O. Cantt Sialkot-51310, Pakistan

Tel: +92 52 4273146 Fax: +92 52 4298566 Email: info@ajmostar.com, sales@ajmostar.com

Rongeurs, Cutters, and Punches

503253 Bone cutter, strong serrated tips, straight, 10.5cm



503254 Bone cutter, strong tips, curved, 10.5cm



503255
Bone cutter, strong serrated tips,
curved, 10.5cm

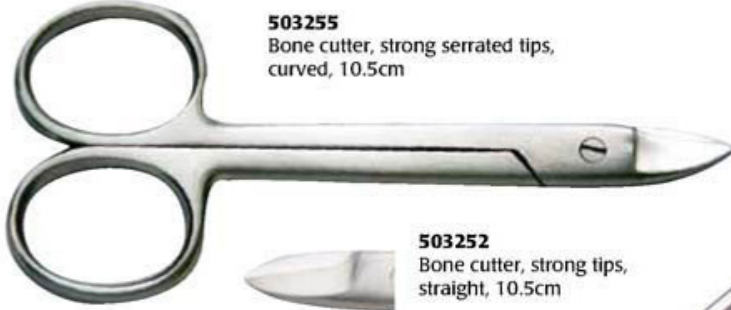

503252
Bone cutter, strong tips,
straight, 10.5cm



Tip Profile:

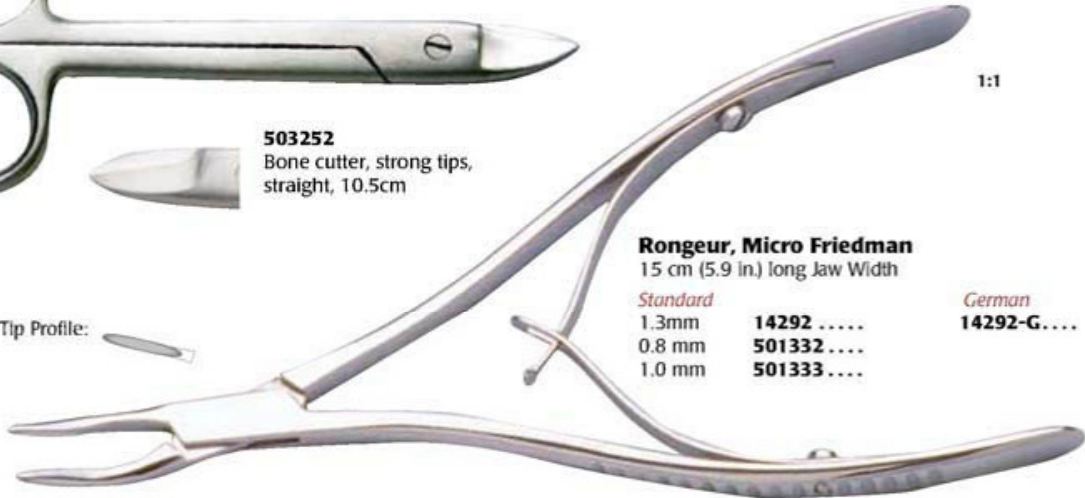

1:1

Rongeur, Micro Friedman

15 cm (5.9 in.) long Jaw Width

Standard

1.3mm **14292**

0.8 mm **501332**

1.0 mm **501333**

German

14292-G....



Rongeur, Side Cutter

15.5 cm (6.1 in.) long, stainless steel

503226



Ajmo Star Surgico

Showali(East.) P.O. Cantt Sialkot-51310, Pakistan

Tel: +92 52 4273146 Fax: +92 52 4298566 Email: info@ajmostar.com, sales@ajmostar.com

Ear Punches and Ear Tags



Ear Tag Applicator
Not actual size.
503292.....™

- 501866 Ear Tags, pack of 100, sequence 000-099
- 501867 Ear Tags, pack of 100, sequence 100-199
- 501868 Ear Tags, pack of 100, sequence 200-299
- 501869 Ear Tags, pack of 100, sequence 300-399
- 501870 Ear Tags, pack of 100, sequence 400-499
- 501871 Ear Tags, pack of 100, sequence 500-599
- 501872 Ear Tags, pack of 100, sequence 600-699
- 501873 Ear Tags, pack of 100, sequence 700-799
- 501874 Ear Tags, pack of 100, sequence 800-899
- 501875 Ear Tags, pack of 100, sequence 900-999
- 501893 Ear Tags, pack of 1000, sequence 000-999



Ear Punch
10 cm (4 in.) long
2 mm diameter 500077....
1 mm diameter 500076....

1:1

Ear Punch
5.7 cm (2.25 in.) long, 2 mm diam punch
500075.....



1:1

Disposable Biopsy Punches, package of 50
Individually packaged in color-coded, transparent, sturdy blister pack to protect cutting edge
Seamless stainless steel razor sharp cutting edge
Ribbed handle provides maximum control and comfort

- 501816 1.5mm diameter
- 501817 2.0mm diameter
- 501818 3.0mm diameter



1:1

Trabecula Punch
Length: 12.5 cm (4.9 in.)
Punch: semicircle, 1 mm diameter
500371.....



1:1



Disposable Safety Scalpels

Retractable blade protects from accidental injury. Complies with the OSHA Directive.



- 501337** Size #10, pack of 10....
- 501338** Size #11, pack of 10....
- 501339** Size #15, pack of 10....



- 500348** Disposable Scalpel, No. 10, sterile, (10/box)
- 500349** Disposable Scalpel, No. 11, sterile, (10/box)
- 500350** Disposable Scalpel, No. 12, sterile, (10/box)
- 500351** Disposable Scalpel, No. 15, sterile, (10/box)
- 500352** Disposable Scalpel, No. 20, sterile, (10/box)
- 500353** Disposable Scalpel, No. 21, sterile, (10/box)
- 500354** Disposable Scalpel, No. 22, sterile, (10/box)
- 500355** Disposable Scalpel, No. 23, sterile, (10/box)
- 500356** Disposable Scalpel, No. 24, sterile, (10/box)

Microsurgical Knives

Sterile, disposable



501731 Microsurgical Knife, 15° 3 mm blade, 13.5 cm (5.25 in.) long (package of 6)



500249 Microsurgical Knife, 15° 5 mm blade, 13.5 cm (5.25 in.) long (package of 6)



500250 Roundstock Ophthalmic Knife, 15° 5.7 mm blade, 13.5 cm (5.25 in.) long (package of 6)

Micro Dissecting Knife

13 cm long, 1 mm blade, right angle
14135....



1:1

Razor Blade Holder

12.5 cm (5 in.) long
round tips
S-shape jaws
14139.....

Tip Profile:



1:1

Razor Blade Holder

12 cm (4.75 in.) long
round tips
convex/concave jaws
Standard **14134**....
German **14134-G..**

Tip Profile:



Special jaw shape prevents blades from slipping



1:1



Ajmo Star Surgico

Showali(East.) P.O. Cantt Sialkot-51310, Pakistan

Tel: +92 52 4273146 Fax: +92 52 4298566 Email: info@ajmostar.com, sales@ajmostar.com

Scalpels, Knives, Blades and Handles

Scalpel Handle #3

13 cm (5 in.) long, stainless steel

Standard **500236**

German **500236-G**....



For Blades #10 ~ #15

Scalpel Handle #4

14 cm (5.5 in.) long, stainless steel

Standard **500237**

German **500237-G**....



For Blades #20 ~ #25

Scalpel Handle #7

16 cm (6.25 in.) long, stainless steel

Standard **500238**...

German **500238-G**



For Blades #10 ~ #15

Sterile stainless steel blades

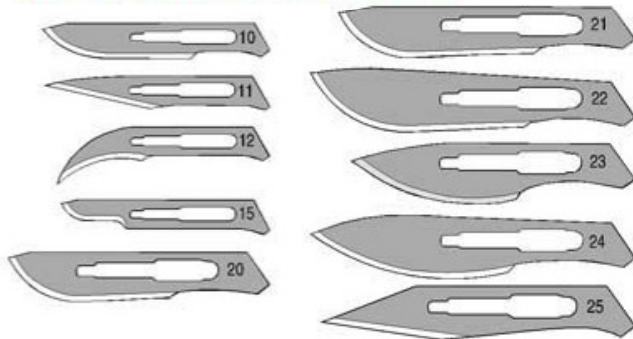

All stainless steel scalpel blades are made by Feather®, using a precise beveling technique to create the edge's micron sharpness. They are the finest blades available.

- 500239** Scalpel Blades #10, stainless steel, sterile (100 / box)
- 500240** Scalpel Blades #11, stainless steel, sterile (100 / box)
- 500241** Scalpel Blades #12, stainless steel, sterile (100 / box)
- 500242** Scalpel Blades #15, stainless steel, sterile (100 / box)
- 500243** Scalpel Blades #20, stainless steel, sterile (100 / box)
- 500244** Scalpel Blades #21, stainless steel, sterile (100 / box)
- 500245** Scalpel Blades #22, stainless steel, sterile (100 / box)
- 500246** Scalpel Blades #23, stainless steel, sterile (100 / box)
- 500247** Scalpel Blades #24, stainless steel, sterile (100 / box)
- 500248** Scalpel Blades #25, stainless steel, sterile (100 / box)

Blade Safe surgical blade remover

will remove blades easily and safely from any style surgical blade handle

501335



BLADES

- 501249** Needle Blades, 6/pk, 4.5 cm
- 501250** Miniature Edged Blades, curved tip, 12/pk, 3.5 cm
- 501251** Miniature Edged Blades, round tip, 12/pk, 3.5 cm



Round Knurled Blade Handle, stainless steel, 10 cm long

Standard **501247** Round Knurled Blade Handle

German **501247-G** Round Knurled Blade Handle

Hex Blade Handle, stainless steel, 10 cm long

Standard **501248** Hex Blade Handle

German **501248-G** Hex Blade Handle



Ajmo Star Surgico

Showali(East.) P.O. Cantt Sialkot-51310, Pakistan

Tel: +92 52 4273146 Fax: +92 52 4298566 Email: info@ajmostar.com, sales@ajmostar.com



Sapphire Knife

Clear blade increases view of tissue

Chemically inert to lymph, blood, and disinfectant solutions

Single crystal sapphire (Al₂O₃), while not as hard as diamond, is still hundreds of times harder than steel razor blades. The durability of the blade guarantees a unique operational life that exceeds one hundred incisions. In addition, the blade and handle can be sterilized using any currently known procedure.

The super sharp cutting edge, mirror surface finish, and low friction coefficient combine to create an accurate, clean cut with minimal tissue trauma. Scarring is thus reduced and incisions heal quickly.

Both the stainless steel and titanium handles feature safety locks to protect the super sharp cutting edge from damage and prevent injuries to medical personnel.



30°

500313



60°

500316



90°

501736

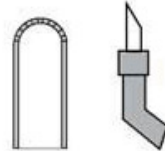

Crescent Blade
front & side view

501761

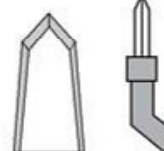

Phaco Blade
front & side view

501762

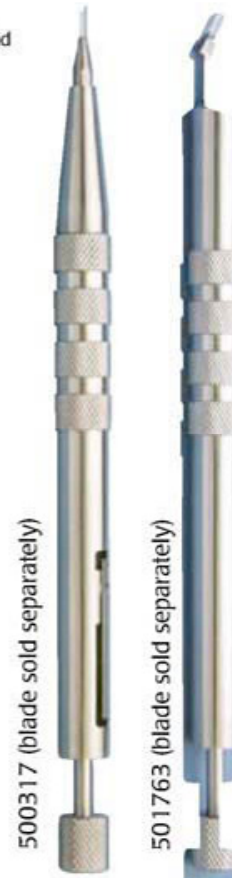

500317 (blade sold separately)

501763 (blade sold separately)

**Custom sizes available
— call for details**

- 500317 Stainless Handle for Sapphire Knife, 13 cm long, retractable
- 501811 Titanium Handle for Sapphire Knife, 13 cm long, retractable

Single Edge Blades for use with above handles 500317 & 501811

- 501760 Sapphire Blade, single edge, 1 mm wide, 0.22mm thick, 15°
- 500313 Sapphire Blade, single edge, 1 mm wide, 0.2mm thick, 30°
- 501304 Sapphire Blade, single edge, 1 mm wide, 0.23mm thick, 45°
- 501735 Sapphire Blade, single edge, 1 mm wide, 0.21mm thick, 60°
- 501736 Sapphire Blade, single edge, 1 mm wide, 0.3mm thick, 90°
- 500315 Sapphire Blade, single edge, 2 mm wide, 0.21mm thick, 30°
- 500325 Sapphire Blade, single edge, 1.4 mm wide, 0.3mm thick, 35°

Double Edge Blades for use with above handles 500317 & 501811

- 500314 Sapphire Blade, double edge lance, 1 mm wide, 0.3mm thick, 35°
- 500316 Sapphire Blade, double edge lance, 2 mm wide, 0.3mm thick, 60°
- 500326 Sapphire Blade, double edge lance, 1.7 mm wide, 0.3mm thick, 60°

Specialty Handle and Blades

- 501763 Stainless Angled Handle for Sapphire Knife, 13 cm long, retractable
- 501812 Titanium Angled Handle for Sapphire Knife, 13 cm long, retractable
- 501761 Crescent Sapphire Blade, 2.8 mm wide, 0.3mm, (fits handles 501763 & 501812)
- 501762 Phaco Sapphire Blade, 2.7/3.4 mm wide, 0.3mm, (fits handles 501763 & 501812)

Sapphire Knife Protection Tray

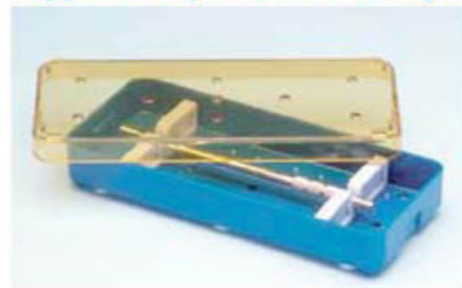

Protect your sapphire knife with a sterilization/protection tray. Fully autoclavable tray safely holds two sapphire knife handles for sterilization and storage.

- 501729 Sterilization/Protection Tray



Ajmo Star Surgico Showali(East.) P.O. Cantt Sialkot-51310, Pakistan

Tel: +92 52 4273146 Fax: +92 52 4298566 Email: info@ajmostar.com, sales@ajmostar.com

Jansen retractor

4.5 in. long, maximum spread 3cm
3 x 3 prongs, blunt

Standard **501770** ..
German **501770-G**

sharp prongs

Standard **501859** ..



1:1

Weitlaner Retractor, self-retaining

Standard	German
501328	501328-G
4", 2x3 prongs, blunt, maximum spread 3cm	
501314	501314-G
4", 2x3 prongs, sharp, maximum spread 4cm	
501722	501722-G
5.5", 3x4 prongs, blunt, maximum spread 4.5cm	
501721	501721-G
5.5", 3x4 prongs, sharp, maximum spread 4cm	
501724	501724-G
6.5", 3x4 prongs, blunt, maximum spread 6.5cm	
501723	501723-G
6.5", 3x4 prongs, sharp, maximum spread 7cm	



Gelpi Retractor

Standard	German
3.5" 501329	
4.5" 501719	
5.5" 501720	501720-G



Senn Retractor

7-in. long	
Standard	German
sharp 501327	501327-G
blunt 501718	501718-G



1:1

U.S. Army Retractor

7-in. long, Set of 2
501330



1:1



Ajmo Star Surgico

Showali(East.) P.O. Cantt Sialkot-51310, Pakistan

Tel: +92 52 4273146 Fax: +92 52 4298566 Email: info@ajmostar.com, sales@ajmostar.com

ALM Self-retaining Retractor

Loop prongs
 Length: 7 cm (2.75 in.)
503675



1:1



Agricola Retractor

Length: 4 cm (1.6 in.)
 Blades: 3 x 3 sharp prongs
 Small, self-retaining retractor perfect for small animal surgery and dissection.
501846



1:1

Goldstein Retractor

Small, self-retaining retractor perfect for small animal surgery and dissection.

Length: 2 cm (0.78 in.)
 Blades: 3 x 3 sharp prongs
 Maximum Spread: 1.0cm
501967



Length: 3 cm (1.18 in.)
 Blades: 3 x 3 sharp prongs
 Maximum Spread: 1.8cm
501968



1:1

Self-retaining Retractor

Length: 5 cm (2 in.)
 Blades: 2.5 cm
 Maximum spread: 4.5 cm
 Small, self-retaining retractor perfect for small animal surgery and dissection.
503209

Length: 4 cm (1.57 in.)
 Blades: 3 x 3 sharp prongs
 Maximum Spread: 3.5cm
501969

Stevenson Retractor, 8 cm (3 in.) long, 3x3 prongs, 3 mm deep

Standard **14131**
German **14131-G** ..



1:1

Maximum spread 15 mm

ALM Self-retaining Retractor, 7 cm (2.75 in.) long, 4x4 prongs

Standard **14240**

German **14240-G**



1:1

Maximum spread 55 mm

Modified ALM Self-retaining Retractor

7 cm (2.75 in.) long, 2x2 prongs
 Smaller, thinner prongs for use on mouse/rat eyelids
501844



1:1

Knapp Speculum, 15 x 6 mm blades, 8.3 cm (3.25 in.) long, maximum spread 25 mm

Standard **14129**

German **14129-G** ..



1:1



Ajmo Star Surgico Showali(East.) P.O. Cantt Sialkot-51310, Pakistan

Tel: +92 52 4273146 Fax: +92 52 4298566 Email: info@ajmostar.com, sales@ajmostar.com

Retractors

Wire Retractors

4 cm (1.6 in.) long
 5 x 5 mm wire blades
 5 mm depth
 maximum spread 15 mm
501993.....

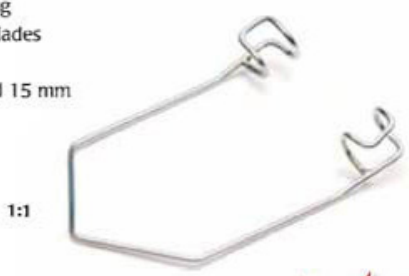

Wire Retractors

4 cm (1.6 in.) long
 13 x 5 mm wire blades
 7 mm depth
 maximum spread 15 mm
501994.....

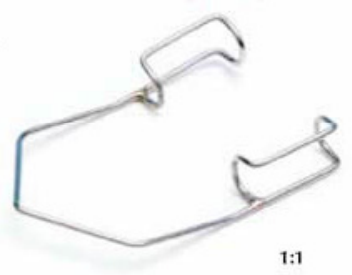

Wire Retractors

5 cm (2 in.) long
 10 x 5 mm blades
 5 mm depth
 maximum spread 13 mm
Standard **14130**.....
German **14130-G**...



Picture is smaller than actual size

Wire Retractors - non-magnetic

4.5 cm (1.8in.) long
 0.8 x 1.5 mm wire blades
 maximum spread 35 mm
503210.....



KD Mouse/Rat Eye Speculum

- 503363** Extra Small, 1cm long, 2mm blades, 1.75mm wide
- 501897** Small, 2.1cm long, 2.2mm blades, 5mm max. spread
- 501898** Medium, 2.1cm long, 3.2mm blades, 6mm max. spread
- 501899** Large, 2.1cm long, 4mm blades, 1cm max. spread



Wire Retractors

5 cm (2 in.) long,
 15 x 10 mm wire blades
 7 mm depth
 maximum spread 25 mm
Standard **500368**.....
German **500368-G**....



Barraquer Retractor

4 cm (1.5 in.) long,
 10 x 4 mm wire blades
 7 mm depth
 maximum spread 3 cm
Standard **500369**....
German **500369-G**..

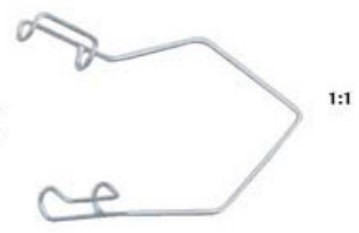

Wire Speculum Titanium

Length: 4.5 cm (1.75 in.)
 Blades: 13.5 mm blades
 Maximum spread: 20 mm 1:1
555801L.....

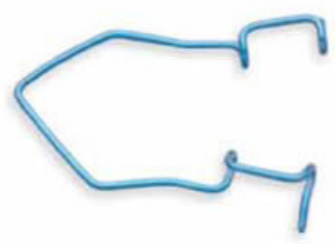

Ajmo Star Surgico Showali(East.) P.O. Cantt Sialkot-51310, Pakistan

Tel: +92 52 4273146 Fax: +92 52 4298566 Email: info@ajmostar.com, sales@ajmostar.com

Micro Vessel Clips, serrated jaws

German

- 501779-G** straight, 0.75 x 4 mm jaws
- 501780-G** straight, 0.8 x 6 mm jaws
- 501781-G** straight, 1 x 8 mm jaws
- 501782-G** straight, 1.5 x 10 mm jaws

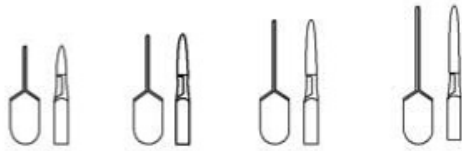

Side and front view illustrations of straight micro vessel clips



- 501783-G** slightly curved, 85g pressure, jaws 1mm wide x 6 mm long
- 501784-G** fully curved, 85g pressure, jaws 1mm wide x 6 mm long...
- 501785-G** 45° angle, 85g pressure, jaws 1mm wide x 6 mm long....

Vessel Clips

- | | |
|--------------|---|
| 15911 | 10 g pressure, jaws 0.5mm wide x 0.6mm long, 5 per pack ... |
| 15913 | 15 g pressure, jaws, 5 per pack |
| 14120 | 30 g pressure, jaws 1mm wide x 5mm long, 5 per pack |
| 14121 | 60 g pressure, jaws 1mm wide x 8mm long, 5 per pack |

Frog Heart Clips



- | | | |
|-----------------------|----------------------|---------------------|
| 501902 | 501903 | 501904 |
| two flat loops | two fine loops | two flat tips |
| 2.5 mm diameter loops | 0.6 mm diameter tips | 1 x 3 mm tips |
| 24 mm long | 17 mm long | 18 mm long |
| 5 per package | 5 per package | 5 per package |

Schwartz Vessel Clips



German

- 501786-G** straight, 1.7 x 8 mm jaws
- 501787-G** slightly angled, 1.7 x 8 mm jaws
- 501788-G** strong angle, 1.7 x 8 mm jaws

Bulldog Clamps



	Standard	German	Standard	German	Standard	German	Standard	German
	14119	14119-G	14118	14118-G	14117	14117-G	14116	14116-G
Description	Micro Bulldog Clamp, curved 8 x 1.2 mm serrated jaws, 3 cm (1 in.) long		Small Bulldog Clamp, straight serrated jaws, 6 cm (2.3 in.) long		Dieffenbach Bulldog Clamp, curved serrated jaws, 6.5 cm (2.5 in.) long		Dieffenbach Bulldog Clamp, 6.5 cm (2.5 in.) long, straight serrated jaws	

Micro Vessel Clip Applier with lock

Applying forceps for Micro Vessel Clips
501783-G, 501784-G, and 501875-G



503200 14.5 cm long

Clip Applicator Forceps



Applying Forceps for Vessel Clips #501786-G, #501787-G, #501788-G, and #15911. 13.8 cm (5.5 in.) long
501999



Applying Forceps



Applying Forceps for Approximator #14084 & Vessel Clips #14120, #15911, and #14121, 10 cm (4 in.) long
14189

Approximator
20 g pressure,
for 0.5 to 1.0 mm vessel
14084



Ajmo Star Surgico Showali(East.) P.O. Cantt Sialkot-51310, Pakistan

Tel: +92 52 4273146 Fax: +92 52 4298566 Email: info@ajmostar.com, sales@ajmostar.com

Needles

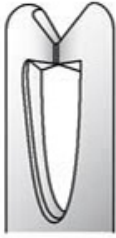

All needles have a Spring Eye which allows the suture to be pressed into the eye instead of threaded.



Taper point needles pierce and spread tissue without cutting it. They are ideal for suturing delicate, soft tissue when minimal trauma is desired.

Cutting edge needles have sharp edges that penetrate easily through tough tissue. They are ideal for suturing skin and dense dermal tissue.



Needle measurements taken across needle from eye to tip:

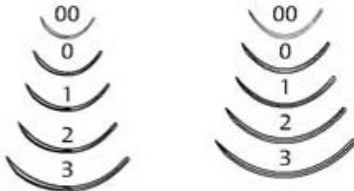
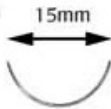

Eye Needles, cutting edge, 5/16 circle (above left)

- 501957** Size 00, 11mm, pack of 12
- 501958** Size 0, 13mm, pack of 12
- 501959** Size 1, 15mm, pack of 12
- 501960** Size 2, 18mm, pack of 12
- 501961** Size 3, 21mm, pack of 12

Eye Needles, taper point, 5/16 circle (above right)

- 501962** Size 00, 11mm, pack of 12
- 501963** Size 0, 13mm, pack of 12
- 501964** Size 1, 15mm, pack of 12
- 501965** Size 2, 18mm, pack of 12
- 501966** Size 3, 21mm, pack of 12

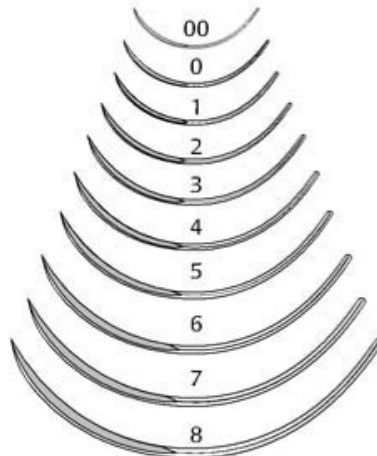

Surgical Needles, cutting edge, 3/8 circle

- 501802** Size 00, 18mm, pack of 12
- 501803** Size 0, 21mm, pack of 12
- 501804** Size 1, 24mm, pack of 12
- 501805** Size 2, 28mm, pack of 12
- 501806** Size 3, 32mm, pack of 12
- 501807** Size 4, 36mm, pack of 12
- 501808** Size 5, 40mm, pack of 12
- 501809** Size 6, 45mm, pack of 12
- 501810** Size 7, 50mm, pack of 12
- 501935** Size 8, 55mm, pack of 12

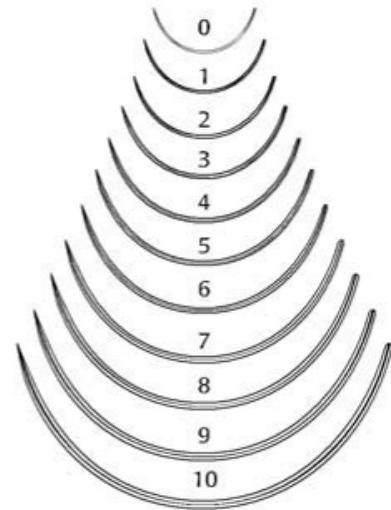

Surgical Needles, taper point, 1/2 circle

- 501936** Size 0, 15mm, pack of 12
- 501937** Size 1, 18mm, pack of 12
- 501938** Size 2, 21mm, pack of 12
- 501939** Size 3, 24mm, pack of 12
- 501940** Size 4, 28mm, pack of 12
- 501941** Size 5, 32mm, pack of 12
- 501942** Size 6, 36mm, pack of 12
- 501943** Size 7, 40mm, pack of 12
- 501944** Size 8, 45mm, pack of 12
- 501945** Size 9, 50mm, pack of 12
- 501946** Size 10, 55mm, pack of 12

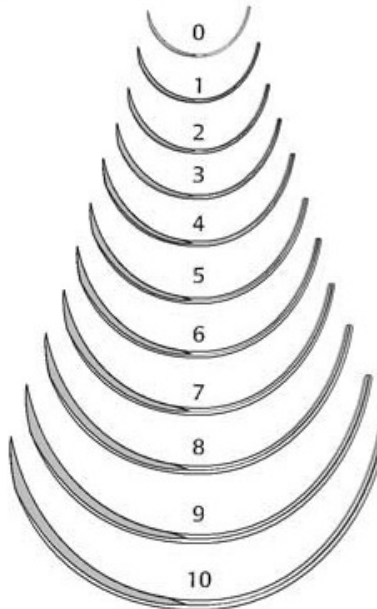

Surgical Needles, cutting edge, 1/2 circle

- 501791** Size 0, 15mm, pack of 12
- 501792** Size 1, 18mm, pack of 12
- 501793** Size 2, 21mm, pack of 12
- 501794** Size 3, 24mm, pack of 12
- 501795** Size 4, 28mm, pack of 12
- 501796** Size 5, 32mm, pack of 12
- 501797** Size 6, 36mm, pack of 12
- 501798** Size 7, 40mm, pack of 12
- 501799** Size 8, 45mm, pack of 12
- 501800** Size 9, 50mm, pack of 12
- 501801** Size 10, 55mm, pack of 12

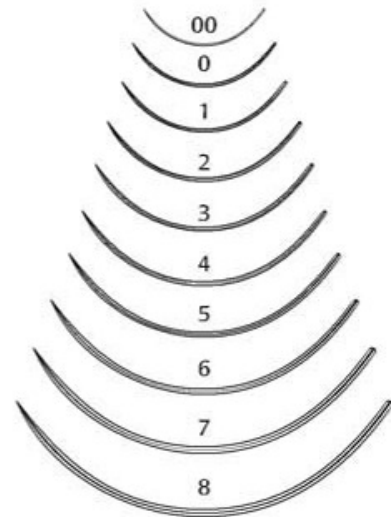

Surgical Needles, taper point, 3/8 circle

- 501947** Size 00, 18mm, pack of 12
- 501948** Size 0, 21mm, pack of 12
- 501949** Size 1, 24mm, pack of 12
- 501950** Size 2, 28mm, pack of 12
- 501951** Size 3, 32mm, pack of 12
- 501952** Size 4, 36mm, pack of 12
- 501953** Size 5, 40mm, pack of 12
- 501954** Size 6, 45mm, pack of 12
- 501955** Size 7, 50mm, pack of 12
- 501956** Size 8, 55mm, pack of 12



Ajmo Star Surgico

Showali(East.) P.O. Cantt Sialkot-51310, Pakistan

Tel: +92 52 4273146 Fax: +92 52 4298566 Email: info@ajmostar.com, sales@ajmostar.com

Clips and Clamps



Staple Remover
12 cm (4.5 in.) long, for use with disposable skin stapler
501830

Reflex Clip Applier

11 cm (4.3 in.) long
for 7 mm clips only
500343



Reflex Clip Applier

11 cm (4.3 in.) long
for 9 mm clips only
500345

Reflex Clip 7 mm
for use with #500343
100/box, Stainless Steel, non-sterile
500344



Reflex Clip 9 mm
for use with #500345
100/box, Stainless Steel, non-sterile
500346

Reflex clip removing forceps

12 cm (4.75 in.) long, for 7 mm and 9 mm clips
500347



Applying Forceps for Silver Clips #500087, 18 cm (7 in.) long

Standard **500088**

German **500088-G**

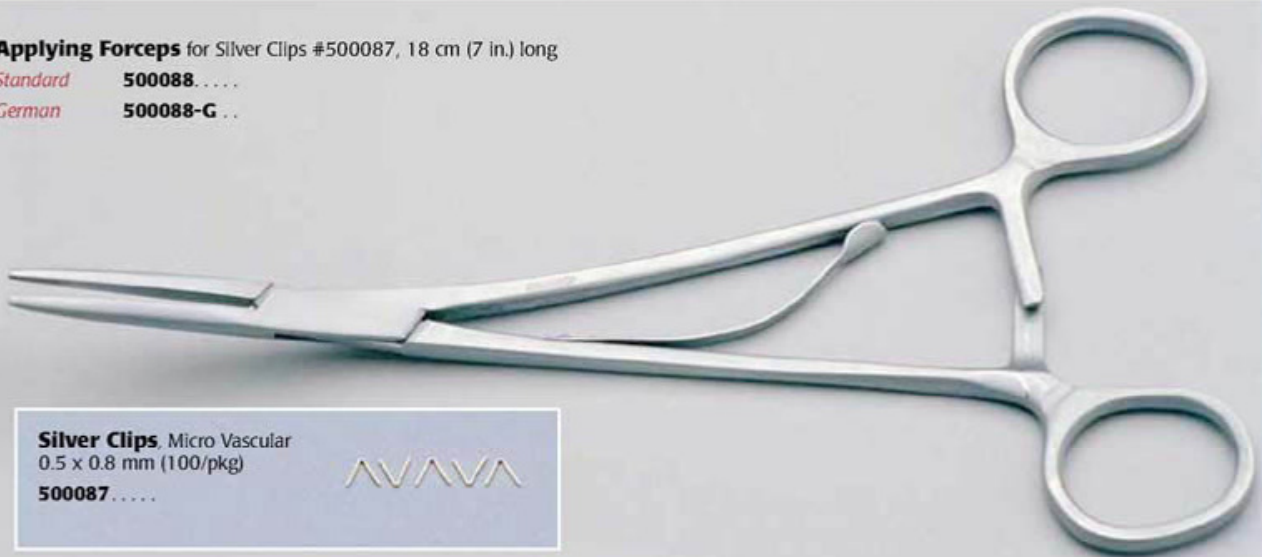

Silver Clips, Micro Vascular
0.5 x 0.8 mm (100/pkg)
500087



Ajmo Star Surgico Showali(East.) P.O. Cantt Sialkot-51310, Pakistan

Tel: +92 52 4273146 Fax: +92 52 4298566 Email: info@ajmostar.com, sales@ajmostar.com

Mayo-Heger Needle Holder, Stainless Steel

15 cm long (6 in.)

V503382



Curved Needle Holder, Titanium

11.5 cm long (4.5 in.)

Curved, 11mm medium jaws, sharp tips

555400NT without lock



Barraquer Needle Holder, Titanium

11.5 cm long (4.5 in.)

Delicate, 9mm gently curved jaws, sharp tips

555402NT without lock

555403NT with lock



Troutman Needle Holder, Curved, Titanium

11.5 cm long (4.5 in.)

10mm gently curved jaws, blunt tips

555406NT without lock

555407NT with lock



Curved Needle Holder, Titanium

11 cm long (4.3 in.)

Curved, 6mm delicate jaws

555408NT without lock

Glover Bulldog Clamps



503236 Glover Bulldog Clamp - straight, smooth tips - 8 cm long with tension adjustment

503238 Glover Bulldog Clamp - straight, smooth tips - 7 cm long with tension adjustment



503237 Glover Bulldog Clamp - curved, smooth tips - 8 cm long with tension adjustment

503239 Glover Bulldog Clamp - curved, smooth tips - 7 cm long with tension adjustment



Ajmo Star Surgico Showali(East.) P.O. Cantt Sialkot-51310, Pakistan

Tel: +92 52 4273146 Fax: +92 52 4298566 Email: info@ajmostar.com, sales@ajmostar.com

Crile-Wood Needle Holder, Stainless Steel,
serrated **Tungsten Carbide** jaws
14.5 cm (5.75 in.) long
Standard **500224...**
German **500224-G.**

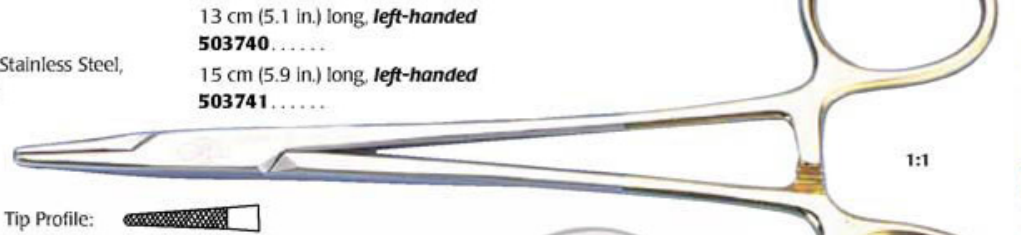

Bruce Clarke Needle Holder, Stainless Steel
12.5 cm (5 in.) long
Serrated jaws with grooves
503219.....



Micro Olsen-Hegar Needle Holder, Stainless Steel
12 cm (4.75 in.) long
Serrated jaws combined with Suture Scissors
Jaw length 10 mm
Tip width 2 mm
501989.....



Olsen-Hegar Needle holder with Suture Scissors,
Stainless Steel, serrated **Tungsten Carbide** jaws
14 cm (5.5 in.) long
Standard **500227**.....
German **500227-G...**
12 cm (4.75 in.) long
Standard **501312**.....
16.5 cm (6.5 in.) long
Standard **501725**.....
German **501725-G...**

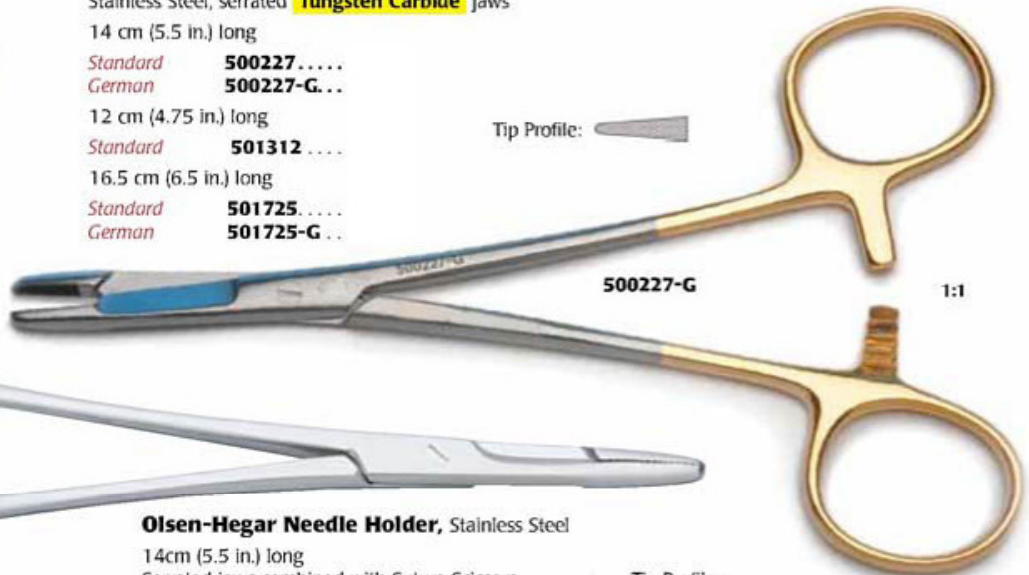

Olsen-Hegar Needle Holder, Stainless Steel
14cm (5.5 in.) long
Serrated jaws combined with Suture Scissors
500023.....
500023-G....



Ajmo Star Surgico Showali(East.) P.O. Cantt Sialkot-51310, Pakistan

Tel: +92 52 4273146 Fax: +92 52 4298566 Email: info@ajmostar.com, sales@ajmostar.com

Webster Needle Holder

12.5 cm (5 in.) long
straight serrated jaws
extra delicate

Standard 14109....

German 14109-G.

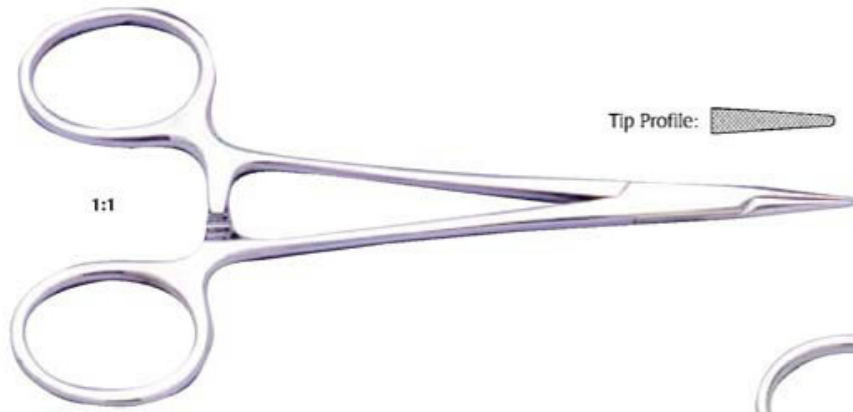

Tip Profile:

1:1

Halsey Needle Holder

14 cm (5.5 in.) long
straight serrated jaws

Standard 14110

German 14110-G.....

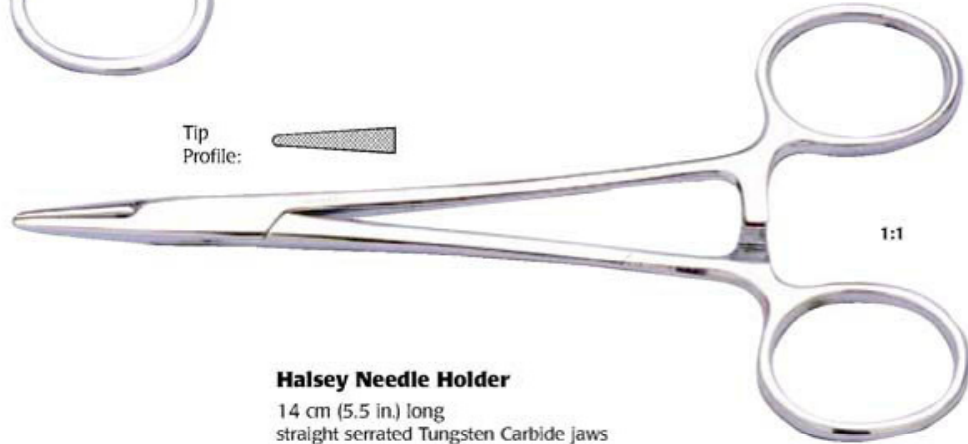

Tip Profile:

1:1

Halsey Needle Holder

14 cm (5.5 in.) long
straight serrated Tungsten Carbide jaws

Standard 15926

German 15926-G.....



1:1

Tip Profile:

Derf Needle Holder

12 cm (5 in.) long

Standard 501246

German 501246-G.....

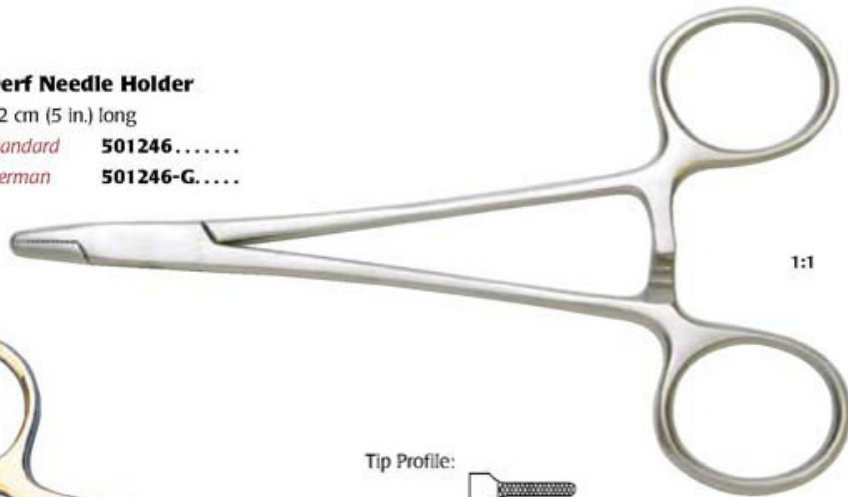

Tip Profile:

1:1

Ryder Needle Holder

13 cm (5 in.) long
serrated Tungsten Carbide jaws

Standard 500226 ...

German 500226-G.

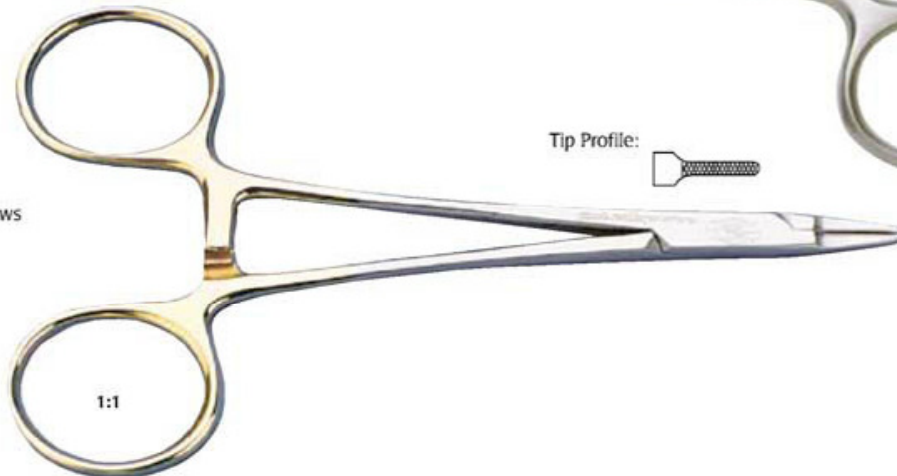

Tip Profile:

1:1



Ajmo Star Surgico

Showali(East.) P.O. Cantt Sialkot-51310, Pakistan

Tel: +92 52 4273146 Fax: +92 52 4298566 Email: info@ajmostar.com, sales@ajmostar.com

Needle Holder

14 cm (5.5 in.) long
 round handles
 0.3 mm tips, straight smooth jaws

Standard **14080**.....
German **14080-G** .



1:1

Tip Profile:

Titanium

14 cm (5.5 in.) long, straight smooth jaws

14361.....

14 cm (5.5 in.) long, curved smooth jaws

501923.....



Castro Olsen-Hegar Needle Holder

15 cm (6 in.) long
 combined with Suture Scissors
 serrated jaws

501998.....

Mathieu Fine Needle Holder

14 cm (5.5 in.) long
 serrated Tungsten Carbide jaws

Standard **500225** ...
German **500225-G** .

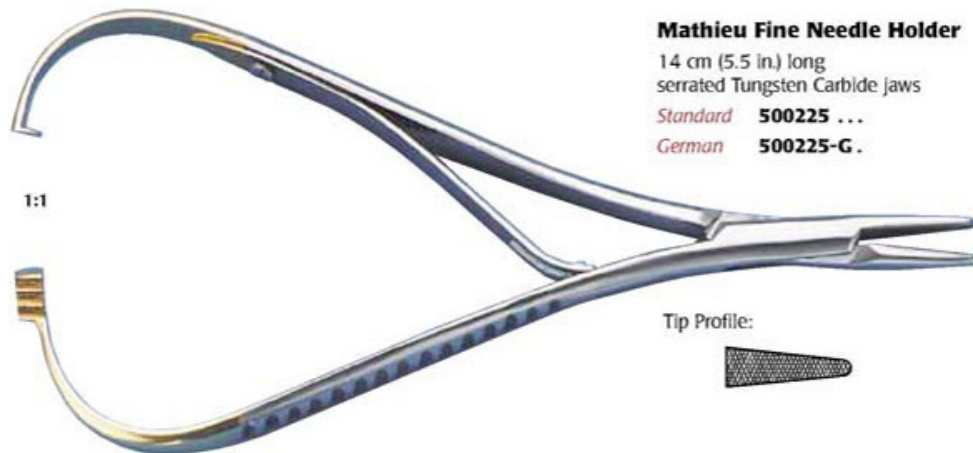

1:1

Tip Profile:

Needle Holder, Round handled

14 cm (5.5 in.) long
 round Hollow handles
 straight smooth jaws

14207.....



Tip Profile:

1:1

Needle Holder, Round handled

14 cm (5.5 in.) long
 round Hollow handles
 curved smooth jaws

14206.....



Tip Profile:

1:1



Ajmo Star Surgico

Showali(East.) P.O. Cantt Sialkot-51310, Pakistan

Tel: +92 52 4273146 Fax: +92 52 4298566 Email: info@ajmostar.com, sales@ajmostar.com

Needle Holders

These squeeze-handle needle holders may be used ambidextrously.

Needle Holder

14 cm (5.5 in.) long, round handles
0.4 mm tips, curved smooth jaws

Standard 14081.....

German 14081-G.....

0.4 mm tips, straight smooth jaws
503357.....



1:1

Needle Holder

14 cm (5.5 in.) long, 0.4 mm tips, smooth jaws
503355..... with lock

20 cm (7.75 in), 0.4 mm tips, smooth jaws
503354..... with lock



1:1

Stevens Needle Holder

13 cm (5 in.) long
straight 1 mm wide serrated tips

Standard 14133.....

German 14133-G ..

Tip Profile: 



1:1

Needle Holder

12.5 cm (5 in.) long
round handles
0.4 mm tips
curved smooth jaws
14132.....

Tip Profile: 

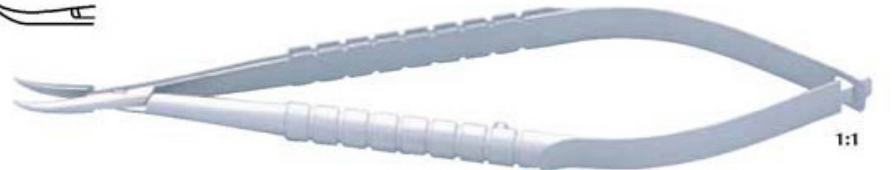

1:1

Castroviejo Needle Holder

14 cm (5.5 in.) long, with lock
Straight 1.2-mm wide serrated tips

Standard 14137.....

German 14137-G ..

Titanium 555419NT .

Serrated Tungsten Carbide jaws
Straight with lock

Standard 500223.....

German 500223-G .

Tip Profile: 



1:1

Smooth tips, 1.2-mm wide

Straight 503257.....

Curved 503258.....

Micro Castroviejo Needle Holder

9cm long, 0.5cm round tips with diamond dust

Straight 503376.....

Curved 503377.....

Tip Profile: 



1:1



Ajmo Star Surgico

Showali(East.) P.O. Cantt Sialkot-51310, Pakistan

Tel: +92 52 4273146 Fax: +92 52 4298566 Email: info@ajmostar.com, sales@ajmostar.com

Jewelers #5 Forceps

Length: 11 cm, 45° bend
 Tips: 0.05 x 0.01 mm

Titanium 555229F.....



1:1

Jewelers #5 Forceps

Length: 11 cm, 45° straight
 Tips: 0.01 x 0.06 mm

Titanium 555227F.....



1:1

Bishop Harmon Forceps, 1 x 2 teeth

9 cm (3.5 in.) long

Standard 501776.....

German 501776-G...

Titanium 555053FT...



1:1

Perone Lasik Forceps

108mm long
 2mm OD rings

Titanium 555827L.....



1:1

Adson Forceps

Tips: 10mm smooth

Titanium 555243F.....



1:1

Dressing Forceps

Length: 10.5 cm (4 in.)

Titanium 503389.....



1:1

Hartman Mosquito Hemostatic Forceps

Titanium 555222F 9 cm (3.5 in.) long, straight.....

Titanium 555223F 9 cm (3.5 in.) long, curved.....

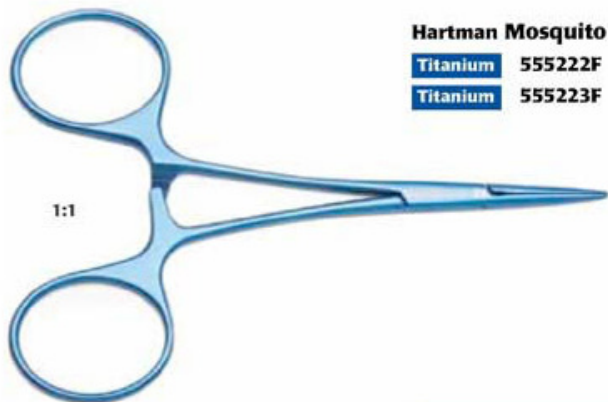

1:1

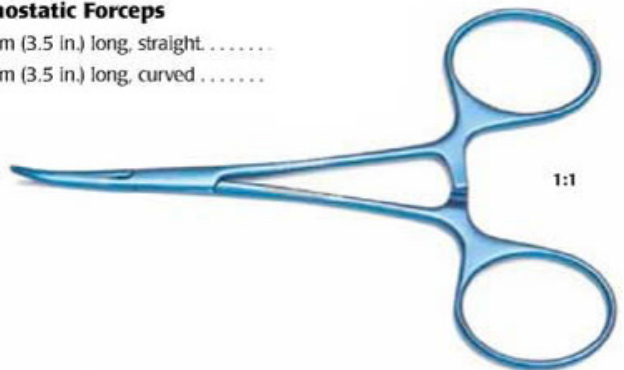

1:1

Delrin Plastic Tweezers

Length 11.8 cm (4.6 in.)

Tips curved

503362



Ajmo Star Surgico

Showali(East.) P.O. Cantt Sialkot-51310, Pakistan

Tel: +92 52 4273146 Fax: +92 52 4298566 Email: info@ajmostar.com, sales@ajmostar.com

Titanium Forceps

- 100% non-corrosive (great for seawater procedures)
- 100% non-magnetic (MRI compatible)
- 40% lighter than stainless steel (reduces hand fatigue)
- Forcep tips coated with tungsten carbide for increased gripping power
- Anodized, non-glare blue finish

Straight Forceps

Length: 11.5 cm (4.5 in.)
 Tips: 1 x 2, 0.12 mm teeth, 5 mm tying platform

Titanium 555047FT



Straight Forceps

Length: 11.5 cm (4.5 in.)
 Tips: 3 mm, 6 mm tying platform

Titanium 555007FT



Calibri Tying Forceps

Length: 11.5 cm (4.5 in.)
 Tips: 3 mm, 4 mm tying platform

Titanium 555008FT



Kelman-McPherson Forceps

Length: 8.5 cm (3.3 in.)
 Tips: 45°angle, 7.5 mm smooth jaw

Titanium 555190FT



Kelman-McPherson Forceps

Length: 11.5 cm (4.5 in.)
 Tips: 45°angle, 7.5 mm smooth jaw

Titanium 555191FT



McPherson Forceps

Length: 11.5 cm (4.5 in.)
 Tips: 45°angle, 6 mm tying platform

Titanium 555009FT



McPherson Forceps

Length: 8.5 cm (3.3 in.)
 Tips: angled, 4.5 mm tying platforms

Titanium 555005FT



Forceps

Length: 8.5 cm (3.3 in.)
 Tips: 12 mm, straight, 4.5 mm tying platforms

Titanium 555001FT



Forceps

Length: 8.5 cm (3.3 in.)
 Tips: straight, 0.12 mm teeth (1x2), 5 mm tying platform

Titanium 555041FT

Tip Profile: 



Jewelers #7 Forceps

Length: 11 cm (4.3 in.)
 Tips: 0.07 x 0.01 mm

Titanium 555230F



Ajmo Star Surgico

Showali(East.) P.O. Cantt Sialkot-51310, Pakistan

Tel: +92 52 4273146 Fax: +92 52 4298566 Email: info@ajmostar.com, sales@ajmostar.com



Radolf Holding Forceps, Stainless Steel

13.5 cm (5.3 in.), curved serrated jaw

503220



1:1

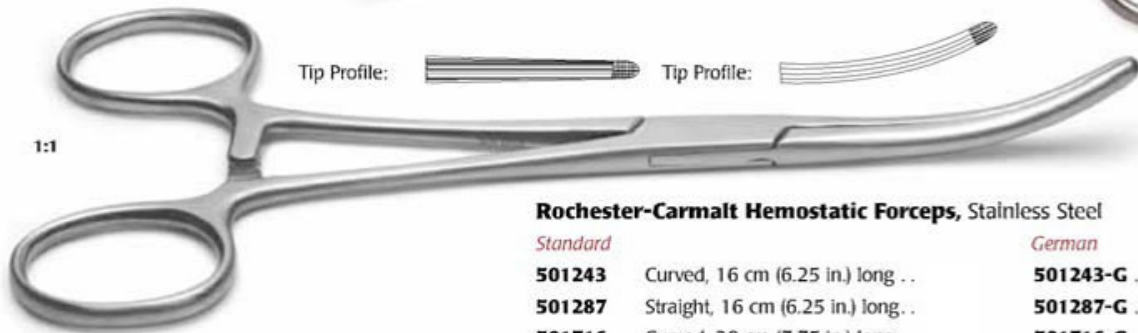

1:1

Tip Profile:



Tip Profile:



Rochester-Carmalt Hemostatic Forceps, Stainless Steel

Standard

German

501243 Curved, 16 cm (6.25 in.) long ..

501243-G

501287 Straight, 16 cm (6.25 in.) long ..

501287-G

501716 Curved, 20 cm (7.75 in.) long ..

501716-G

501717 Straight, 20 cm (7.75 in.) long ..

501717-G

Tip Profile:



Tip Profile:



Rochester-Pean Hemostatic Forceps, Stainless Steel

Standard

German

501325 Straight, 16 cm (6.25 in.) long

501325-G

501706 Curved, 16 cm (6.25 in.) long

501706-G

501707 Straight, 19 cm (7.5 in.) long

501707-G

501708 Curved, 19 cm (7.5 in.) long

501708-G

Tip Profile:



Mixer Hemostatic Forceps, Stainless Steel

"Baby", right angle, 14 cm (5.5 in.) long

Standard **501240**

German **501240-G**

Tip Profile:



Micro Alligator Forceps, Stainless Steel

8 cm (3 in.) shaft, 0.5 x 4.5 mm serrated jaw

500446

Micro Crocodile Forceps, Stainless Steel

8 cm (3 in.) shaft, 3 mm serrated jaw

501211

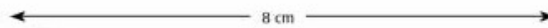

Alligator Forceps, Stainless Steel

9 cm (3.5 in.) shaft, 3 mm cupped jaw

501992



Ajmo Star Surgico

Showali(East.) P.O. Cantt Sialkot-51310, Pakistan

Tel: +92 52 4273146 Fax: +92 52 4298566 Email: info@ajmostar.com, sales@ajmostar.com

Allis Tissue Forceps, Stainless Steel

6", 4x5 teeth

- Standard* **501324**
- German* **501324-G**.....

Tip Profile:

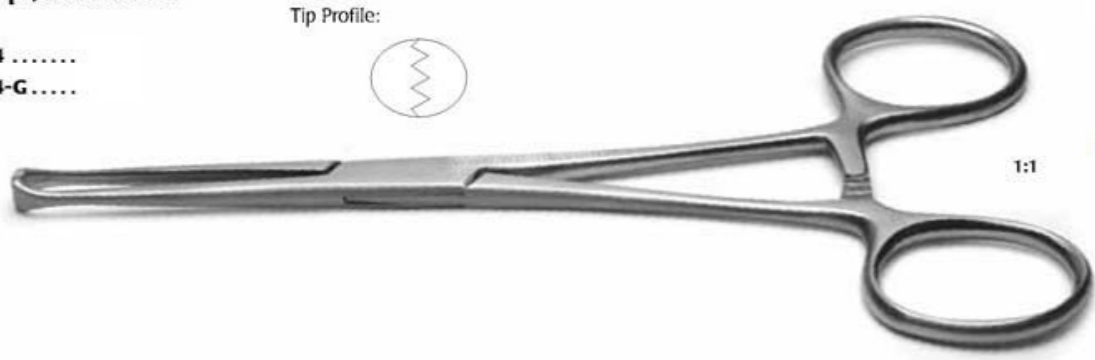

1:1

Kelly Hemostatic Forceps, Stainless Steel

Standard

- 501241** Straight, 14 cm (5.5 in.) long
- 501288** Curved, 14 cm (5.5 in.) long
- 501714** Straight, 15.5 cm (6 in.) long
- 501715** Curved, 15.5 cm (6 in.) long.....

German

- 501241-G**.....
- 501288-G**.....
- 501714-G**.....
- 501715-G**.....

Tip Profile:

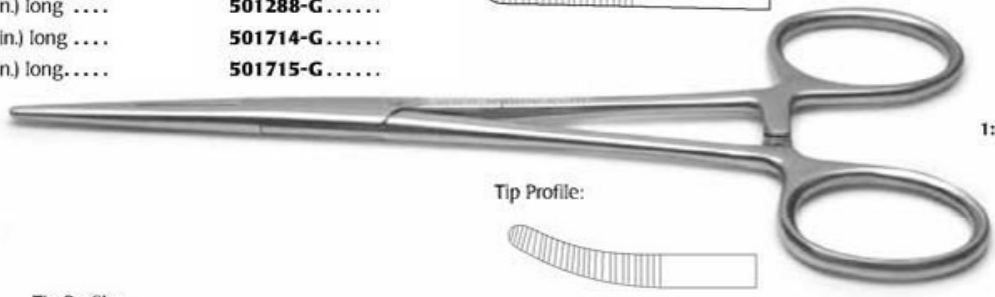
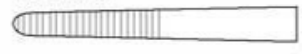

1:1

Tip Profile:

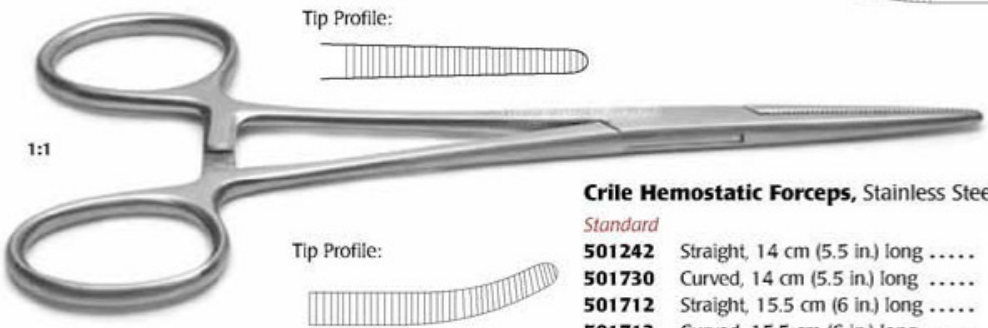

1:1

Tip Profile:



Tip Profile:



Crile Hemostatic Forceps, Stainless Steel

Standard

- 501242** Straight, 14 cm (5.5 in.) long
- 501730** Curved, 14 cm (5.5 in.) long
- 501712** Straight, 15.5 cm (6 in.) long
- 501713** Curved, 15.5 cm (6 in.) long.....
- 503230** Straight, smooth jaw, 6.25 in. long..
- 503229** Curved, smooth jaw, 6.25 in. long..
- 503228** Curved, smooth jaw 14 cm long...
- 503227** Straight, smooth jaw 14 cm long..

German

- 501242-G**.....
- 501730-G**.....
- 501712-G**.....
- 501713-G**.....

Rochester-Oschner Hemostatic Forceps, Stainless Steel

Standard

- 501709** Straight, 14 cm (5.5 in.) long.....
- 501710** Curved, 14 cm (5.5 in.) long.....
- 501326** Straight, 16 cm (6.25 in.) long.....
- 501711** Curved, 16 cm (6.25 in.) long.....

German

- 501709-G**.....
- 501710-G**.....
- 501326-G**.....
- 501711-G**.....

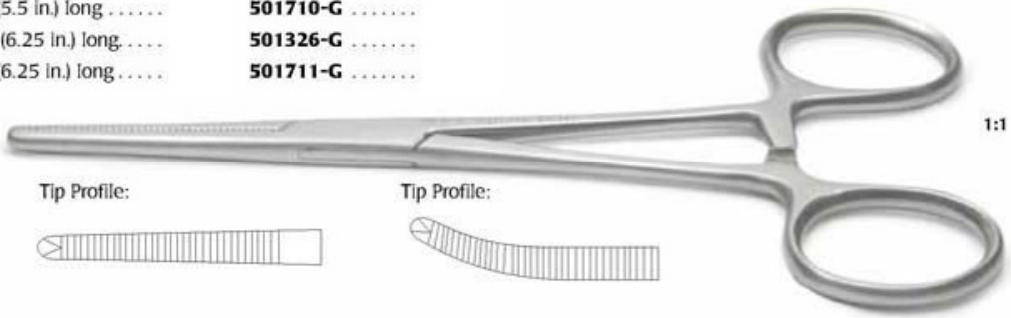

1:1

Tip Profile:



Tip Profile:



Ajmo Star Surgico

Showali(East.) P.O. Cantt Sialkot-51310, Pakistan

Tel: +92 52 4273146 Fax: +92 52 4298566 Email: info@ajmostar.com, sales@ajmostar.com

Filter Forceps, Stainless Steel

Length	11 cm (4.3 in.)
Tips	bent flat jaw
500457	



Wafer Handling Forceps, Stainless Steel

Length	11 cm (4.3 in.)
Tips	angled 30° jaw
501303	



Backhaus Towel Clamp, Stainless Steel

Length	9 cm (3.5 in.), locking handle
Tips	Curved
Standard	501320
German	501320-G

Length	13 cm (5.25 in.), locking handle
Tips	Curved
Standard	501700
German	501700-G



Jones Towel Clamp, Stainless Steel

Length	9 cm (3.5 in.)
Tips	Curved
V503380	



Micro Hemostatic Forceps, Stainless Steel

Length	12.5 cm (5 in.), straight,
Tips	serrated, 0.4 x 0.8 mm
Standard	500451
German	500451-G
Length	12.5 cm (5 in.), curved
Tips	serrated, 0.4 x 0.8 mm
Standard	500452
German	500452-G
Length	12.5 cm (5 in.), right-angle
Tips	serrated, 0.4 x 0.8 mm tips
Standard	503360

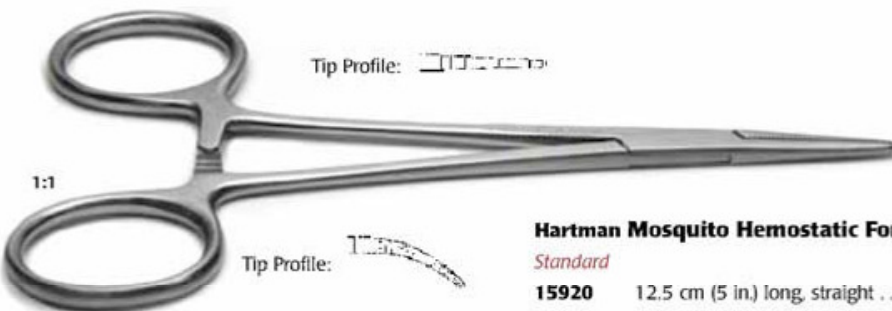
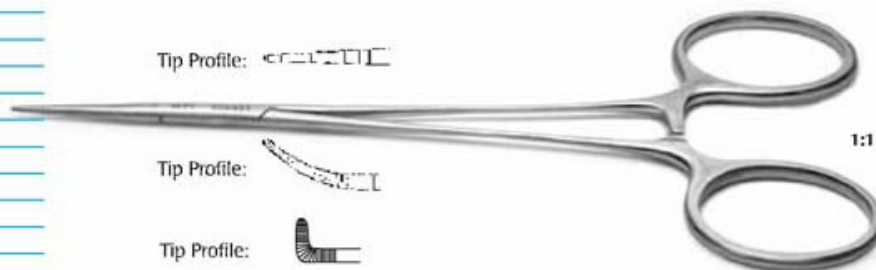

Hartman Mosquito Hemostatic Forceps, Stainless Steel

Standard		German
15920	12.5 cm (5 in.) long, straight	15920-G
15921	12.5 cm (5 in.) long, curved	15921-G
501705	9 cm (3.5 in.) long, straight	501705-G
501291	9 cm (3.5 in.) long, curved	501291-G



Ajmo Star Surgico

Showali(East.) P.O. Cantt Sialkot-51310, Pakistan

Tel: +92 52 4273146 Fax: +92 52 4298566 Email: info@ajmostar.com, sales@ajmostar.com

Microintraocular Forceps, Stainless Steel

Length:14 cm (5.5 in.)
 Jaws:2.5 x 0.3 x 0.25mm (lxwxt), 1.5mm maximum opening
500373
500373-T **titanium handle**



1:1

Length:14 cm (5.5 in.)
 Jaws:3 x 0.6 x 0.4mm (lxwxt), 1.4mm maximum opening
501212
501212-T **titanium handle**

Tip Profile: 

Vessel Cannulation Forceps, Stainless Steel

10 cm (4 in.) long; for 0.5mm diameter cannula
500377



1:1

Vessel Cannulation forceps, Stainless Steel
 10 cm (4 in.) long; for 1.0 mm diameter cannula
500453

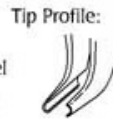

Vessel cannulation forceps are designed to insert small catheters into vessels. The small hollow jaws of the forceps ensure a secure insertion without damaging the fine tubes.

Filter Forceps, Stainless Steel

Polypropylene finger grip, 11 cm (4.3 in.) long,
 straight flat jaw
500455 **Great for gel handling**



1:1

Filter Forceps, Stainless Steel

11 cm (4.3 in.) long, straight flat jaw
Standard *German*
500456 **500456-G** **Great for gel handling**

Great for gel handling



1:1

Micro Cannula

- 0.4mm O.D., 0.2mm I.D. tubing
- Autoclavable
- Biocompatible Perfluorocarbon tubing material



This micro cannula is ideal for placement in the carotid or femoral artery of mice, rats, and other small animal blood vessels. It can be used with a pressure transducer (WPI'S **BLPR2**) for blood pressure measurement, or in conjunction with a micro-syringe injection system (like WPI'S **UMP3** or **MMP** pumps). The incorporated standard female luer fitting makes connecting to existing experimental plumbing quick

and easy. The cannula is provided with a contoured-tip stainless steel stylet (trocar) to facilitate placement using established techniques. A movable "shoulder" ring provides a tie-in point to prevent accidental removal. The cannula may be left in place for 2 hours or more, and with proper care and cleaning, may be re-used multiple times. Instructions for use included.

KZ1101 Micro Cannula, 3"

Horticultural Forceps, Stainless Steel

12.5 cm (5 in.) long
 Wide, angled tips are only 0.4mm thick.
 These forceps were designed for extracting seedling plugs from horticulture trays without damaging the fragile root system.

503411 Horticultural Forceps

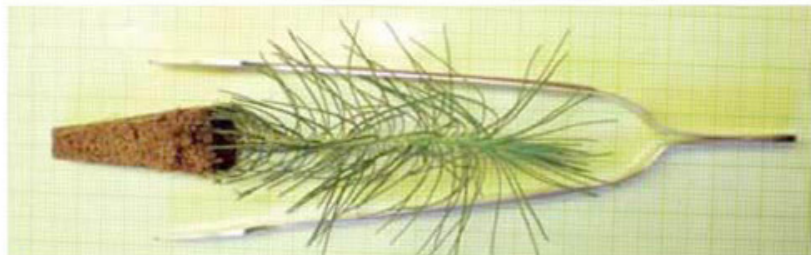

1:1



Ajmo Star Surgico

Showali(East.) P.O. Cantt Sialkot-51310, Pakistan

Tel: +92 52 4273146 Fax: +92 52 4298566 Email: info@ajmostar.com, sales@ajmostar.com

Microintraocular Forceps, Stainless Steel

Length:14 cm (5.5 in.)
 Jaws:2.5 x 0.3 x 0.25mm (lxwxt), 1.5mm maximum opening
500373
500373-T **titanium handle**



1:1

Length:14 cm (5.5 in.)
 Jaws:3 x 0.6 x 0.4mm (lxwxt), 1.4mm maximum opening
501212
501212-T **titanium handle**

Tip Profile: 

Vessel Cannulation Forceps, Stainless Steel

10 cm (4 in.) long; for 0.5mm diameter cannula
500377



1:1

Vessel Cannulation forceps, Stainless Steel
 10 cm (4 in.) long; for 1.0 mm diameter cannula
500453

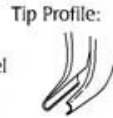

Vessel cannulation forceps are designed to insert small catheters into vessels. The small hollow jaws of the forceps ensure a secure insertion without damaging the fine tubes.

Filter Forceps, Stainless Steel

Polypropylene finger grip, 11 cm (4.3 in.) long,
 straight flat jaw
500455

Great for gel handling



1:1

Filter Forceps, Stainless Steel

11 cm (4.3 in.) long, straight flat jaw
 Standard German
500456 **500456-G**

Great for gel handling



1:1

Micro Cannula

- 0.4mm O.D., 0.2mm I.D. tubing
- Autoclavable
- Biocompatible Perfluorocarbon tubing material



This micro cannula is ideal for placement in the carotid or femoral artery of mice, rats, and other small animal blood vessels. It can be used with a pressure transducer (WPI'S **BLPR2**) for blood pressure measurement, or in conjunction with a micro-syringe injection system (like WPI'S **UMP3** or **MMP** pumps). The incorporated standard female luer fitting makes connecting to existing experimental plumbing quick

and easy. The cannula is provided with a contoured-tip stainless steel stylet (trocar) to facilitate placement using established techniques. A movable "shoulder" ring provides a tie-in point to prevent accidental removal. The cannula may be left in place for 2 hours or more, and with proper care and cleaning, may be re-used multiple times. Instructions for use included.

KZ1101 Micro Cannula, 3"

Horticultural Forceps, Stainless Steel

12.5 cm (5 in.) long
 Wide, angled tips are only 0.4mm thick.
 These forceps were designed for extracting seedling plugs from horticulture trays without damaging the fragile root system.

503411 Horticultural Forceps

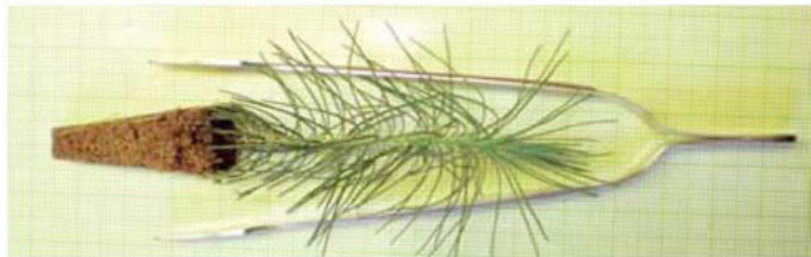

1:1



Ajmo Star Surgico Showali(East.) P.O. Cantt Sialkot-51310, Pakistan

Tel: +92 52 4273146 Fax: +92 52 4298566 Email: info@ajmostar.com, sales@ajmostar.com

Round-handled Forceps

By hollowing out the handles of long, round-handled instruments, the overall weight is decreased. This makes them efficient and non-fatiguing when operating under a microscope. Made from high quality stainless steel, these instruments are an excellent addition to a microsurgical instrument kit.

Round, Hollow Handle Forceps, Stainless Steel

Length: 15 cm (6 in.)

Tips: 0.15 mm tips bent at 45°

14209.....

Tip Profile: 



1:1

Round, Hollow Handle Forceps, Stainless Steel

Length: 15 cm (6 in.)

Tips: straight 0.15 mm

Standard 14113.....

German 14113-G...

Tip Profile: 



1:1

Round, Hollow Handle Forceps, Stainless Steel

Length: 15 cm (6 in.)

Tips: curved 0.3 mm tips

Tip Profile: 

Standard 14114.....

German 14114-G...



1:1

Dilator Forceps, Stainless Steel

Length: 14 cm (5.5 in.)

Tips: straight 0.15 mm tips

15910.....

Tip Profile: 



1:1

Round, Hollow Handle Forceps, Stainless Steel

Length: 14 cm (5.5 in.)

Tips: straight 0.15 mm

14211.....



1:1

Round, Hollow Handle Forceps, Stainless Steel

Length: 14 cm (5.5 in.)

Tips: straight 0.15 mm tips with tying platform

14079.....



1:1

Round, Hollow Handle Forceps, Stainless Steel

Length: 14 cm (5.5 in.)

Tips: straight 0.3 mm

14210.....



1:1

DeBaKey Forceps, Stainless Steel

16 cm (6.25 in.) long, angled, micro, jaw width 1.2 mm, atraumatic

503213....



16 cm (6.25 in.) long, micro, jaw width 1.2 mm, straight, atraumatic
503212....

1:1



Ajmo Star Surgico

Showali(East.) P.O. Cantt Sialkot-51310, Pakistan

Tel: +92 52 4273146 Fax: +92 52 4298566 Email: info@ajmostar.com, sales@ajmostar.com

Teflon-Coated Cupped Forceps, Stainless Steel
501983
 Length 15.25 cm (6 in.)
 Tips 3.5mm diameter



Special cupped forceps allow atraumatic gripping of organs and other delicate tissue.



1:1

Plastic-Coated Cupped Forceps, Stainless Steel
501984
 Length 12.5 cm (5 in.)
 Tips 3.5mm diameter



1:1

Teflon-Coated Tweezers, Stainless Steel
503361
 Length 110 mm
 Tips Narrow tips, 0.25 x 0.098mm



1:1



Russian Forceps, Stainless Steel
501987
 Length 15.25cm (6 in.)
 Tips serrated, oval, 7mm diameter



1:1

DeBakey Forceps, Stainless Steel
 Length 15 cm (6 in.)
 Tips delicate, jaw width 1.5 mm
 Standard **501239**
 German **501239-G**
 Tips 45 degree angled tip
 Standard **501996**



Atraumatic teeth grip tissue, vessels, and organs without damage.



1:1



For rodent handling.

Rubber-tipped Forceps, Stainless Steel
 Length 21cm (8.25 in.)
503370



Graefe Fixation Forceps, Stainless Steel

Length 11.5cm (4.5 in.)

Tips 4mm wide, 5x5 teeth

501988



1:1

Tip Profile:



1:1

Dressing Forceps, Stainless Steel

	Standard	German	Standard	German	Standard	German	Standard	German
	501217	501217-G	500363	500363-G	500364	500364-G	500365	500365-G
Length	12.5 cm (5 in.)		15.5 cm (6 in.)		25.5 cm (10 in.)		30.5 cm (12 in.)	
Tips	Serrated		Serrated		Serrated		Serrated	

Micro Tweezer, Stainless Steel

Length 15 cm (6 in.)

Tips serrated, angled

German **501727-G**



1:1

Dressing Forceps, Stainless Steel

15908 **503283**

Length 12.5 cm (5 in.) 12.5 cm (5 in.) 12.5 cm (5 in.)

Tips straight, sharp straight, round straight

Tip Profile:



1:1

Gillies Dissecting Forceps, Stainless Steel

Length 15.5 cm (6 in.) 15.5 cm (6 in.)

Tips 1 x 2 teeth 1 x 2 teeth, **Tungsten Carbide** jaws

Standard **501266**

501265

German **501266-G**

501265-G



1:1

McIndoe Dressing Forceps, Stainless Steel

Length 15.5 cm (6 in.) 15.5 cm (6 in.)

Tips serrated serrated, **Tungsten Carbide** jaws

Standard **501268**

501267

German **501268-G**

501267-G



1:1



Ajmo Star Surgico

Showali(East.) P.O. Cantt Sialkot-51310, Pakistan

Tel: +92 52 4273146 Fax: +92 52 4298566 Email: info@ajmostar.com, sales@ajmostar.com

Graefe Forceps, Stainless Steel

Length	7 cm (2.75 in.)	7 cm (2.75 in.)
Tips	0.7 mm, serrated, straight	0.7 mm, serrated, curved
Standard	14142	501215
German	14142-G	501215-G

Tip Profile:



1:1

Iris Forceps, Stainless Steel

Length	10 cm (4 in.)
Tips	0.8 mm, serrated, straight
Standard	15914
German	15914-G

Tip Profile:



1:1

Iris Forceps, Stainless Steel

Length	10 cm (4 in.)
Tips	0.8 mm, serrated, curved
Standard	15915
German	15915-G

Tip Profile:



1:1

Iris Forceps, Stainless Steel

Length	10 cm (4 in.)
Tips	0.8 mm, 1x2 teeth, curved
Standard	15917
German	15917-G

Tip Profile:



1:1

Tissue Forceps, Stainless Steel



1:1

Length	14.5 cm (5.7 in.)
Tips	4 x 5 teeth
503311	



Length	14.5 cm (5.7 in.)
Tips	2 x 3 teeth
503313	



Length	14.5 cm (5.7 in.)
Tips	3 x 4 teeth
503312	



Tissue Forceps, Stainless Steel

Length	12.5 cm (5 in.)
Tips	Straight, 1 x 2 teeth
Standard	15918
German	15918-G

Length	12.5 cm (5 in.)
Tips	curved, 1 x 2 teeth
Standard	501216
German	501216-G



1:1

Tissue Forceps, Stainless Steel

Length	15 cm (6 in.)
Tips	straight, 1 x 2 teeth
German	501742-G
Length	15 cm (6 in.)
Tips	straight, 2 x 3 teeth
German	501741-G



Ajmo Star Surgico

Showali(East.) P.O. Cantt Sialkot-51310, Pakistan

Tel: +92 52 4273146 Fax: +92 52 4298566 Email: info@ajmostar.com, sales@ajmostar.com

Ring-Tipped Forceps with adjustment screw

503202
Length
Rings 4.8mm ID, 6.0mm OD



Ring-Tipped Forceps with adjustment screw

503203
Length
Rings 2.2mm ID, 3.0mm OD



Adson Forceps, Stainless Steel Tip Profile:

Length 12 cm (4.75 in.)
Tips 1 x 2 teeth, Tungsten Carbide jaws
Standard 500178
German 500178-G



1:1

Adson Forceps, Stainless Steel Tip Profile:

Length 12 cm (4.75 in.)
Tips 1 x 2 teeth
Standard 500092
German 500092-G



1:1

Micro Adson Tissue Forceps, Stainless Steel Tip Profile:

Length 12 cm (4.75 in.)
Tips 0.8 mm, 1 x 2 teeth, fine point
Standard 501244
German 501244-G

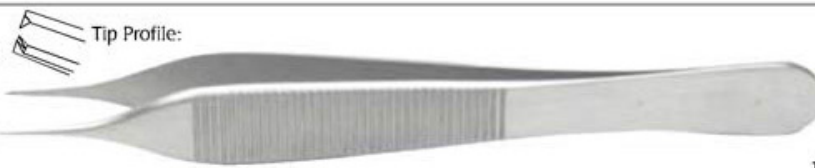

1:1

Micro Adson Dressing Forceps, Stainless Steel Tip Profile:

Tips Serrated, fine point
Length 12 cm (4.75 in.)
Standard 501245
German 501245-G



1:1

Adson-Brown Forceps, Stainless Steel Tip Profile:

Length 12 cm (4.75 in.)
Tips Tungsten Carbide jaws with 7x7 side grasping teeth
Standard 500177
German 500177-G



1:1

Adson Forceps, Stainless Steel Tip Profile:

Length 12 cm (4.75 in.)
Tips Serrated Tungsten Carbide jaws
Standard 500222
German 500222-G



1:1

Adson Forceps, Stainless Steel Tip Profile:

Length 12 cm (4.75 in.)
Tips Serrated
Standard 14226
German 14226-G



1:1



Ajmo Star Surgico

Showali(East.) P.O. Cantt Sialkot-51310, Pakistan

Tel: +92 52 4273146 Fax: +92 52 4298566 Email: info@ajmostar.com, sales@ajmostar.com

Ceramic-tipped Forceps

Zirconia ceramic forceps have several unique properties that are not present in metal forceps.

- Ceramic contains no metal, therefore, the forceps will not leave any trace metal residue on tissue. This is especially useful in forensic science research.
- Ceramic is not electrically conductive so it can be used for handling gels in an electrophoresis bath.
- Ceramic's corrosion resistance allows its use in highly corrosive solutions. For example, clean quartz cover glass or lithographic produced chip sensors in an acid solution without damaging the forceps.
- Ceramic's low heat conductivity and high heat resistance allow it to hold parts in a flame for sterilizing or fabricating. Although the flame will eventually reduce the strength of the ceramic tip, it will be minimal.

Dumont #7, Dumoxel Steel, non-magnetic

	501208
Length	12 cm (4.75 in.)
Tips	0.4 x 0.3 mm Ceramic



1:1

Dumont #3C, Dumoxel Steel, non-magnetic

	501209
Length	11 cm (4.3 in.)
Tips	0.4 x 0.3 mm Ceramic



1:1

Tip Profile:

Zirconia Ceramic Forceps,
plastic handles

	501207
Length	14 cm (5.5 in.)
Tips	9 mm Ceramic



1:1

Forceps

Bishop Harmon Forceps,, Stainless Steel

	<i>Standard</i>	<i>German</i>
	501775	501775-G
Length	9 cm (3.5 in.)	9 cm (3.5 in.)
Tips	serrated	serrated



1:1

Graefe Forceps,, Stainless Steel

	<i>Standard</i>	<i>German</i>
	14141	14141-G
Length	7 cm (2.75 in.)	7 cm (2.75 in.)
Tips	0.7 mm, curved, 1x2 teeth	0.7 mm, curved, 1x2 teeth

Tip Profile:



1:1

Graefe Forceps,, Stainless Steel

	<i>Standard</i>	<i>German</i>
	14140	14140-G
Length	7 cm (2.75 in.)	7 cm (2.75 in.)
Tips	0.7 mm, straight, 1x2 teeth	0.7 mm, straight, 1x2 teeth

Tip Profile:



1:1

Iris Forceps,, Stainless Steel

	<i>Standard</i>	<i>German</i>
	15916	15916-G
Length	10 cm (4 in.)	10 cm (4 in.)
Tips	0.8 mm, straight, 1x2 teeth	0.8 mm, straight, 1x2 teeth

Tip Profile:



1:1



Ajmo Star Surgico

Showali(East.) P.O. Cantt Sialkot-51310, Pakistan

Tel: +92 52 4273146 Fax: +92 52 4298566 Email: info@ajmostar.com, sales@ajmostar.com

Economy Fine Tweezers

Made of quality stainless steel, these tweezers are useful for general dissections where ultrafine tips are not necessary. Economically priced, they are affordable enough for everyone to have their own instruments.

All tweezers on this page are available individually and in packages of 6.

Economy Tweezer, Style 1, Stainless Steel

Length	11 cm (4.3 in.)
Tips	0.45 x 0.55 mm
501974-6	
501974	



Economy Tweezer, Style 2, Stainless Steel

Length	11 cm (4.3 in.)
Tips	0.40 x 0.55 mm
501975-6	
501975	



Economy Tweezer, Style 3, Stainless Steel

Length	11 cm (4.3 in.)
Tips	0.20 x 0.40 mm
501976-6	
501976	



Economy Tweezer, Style 3C, Stainless Steel

Length	11 cm (4.3 in.)
Tips	0.40 x 0.45 mm
501977-6	
501977	



Economy Tweezer, Style 4, Stainless Steel

Length	11 cm (4.3 in.)
Tips	0.40 x 0.45 mm
501978-6	
501978	



Economy Tweezer, Style 5, Stainless Steel

Length	11 cm (4.3 in.)
Tips	0.40 x 0.45 mm
501979-6	
501979	



Economy Tweezer, Style 6, Stainless Steel

Length	11 cm (4.3 in.)
Tips	0.40 x 0.50 mm
501980-6	
501980	



Economy Tweezer, Style 7, Stainless Steel

Length	11 cm (4.3 in.)
Tips	0.40 x 0.50 mm
501981-6	
501981	



Dumont #7, Dumoxel Steel, self-closing

501206
Length 12 cm (4.75 in.)
Tips 0.08 x 0.04 mm

Tip Profile: ▲



1:1

Dumont #7, Stainless Steel, self-closing

503234
Length 12 cm (4.75 in.)
Tips 1.50 x 0.20 mm, flat and rounded



1:1

Dumont Forceps, Stainless Steel

503232
Length 12 cm (4.75 in.)
Tips 0.60 x 0.20 mm, flat and rounded



1:1

Dumont Forceps, Stainless Steel

503233
Length 12 cm (4.75 in.)
Tips 2.0 x 0.20 mm, wide square tips



1:1

Dumont Fine Tip, Dumoxel Steel, non-magnetic

503290
Length 13.5 cm (5.3 in.)
Tips Bent 45°



1:1

Dumont Fine Tip, Dumoxel Steel, non-magnetic

503291
Length 13.5 cm (5.3 in.)
Tips Straight



1:1

Dumont Tweezers, Stainless Steel

503369
Length 11.5 cm (5.3 in.)
Tips Serrated, 0.17 x 0.10 mm



1:1

Dumont Vessel Cannulation Forceps, Stainless Steel

Length 13cm
Cannulation 0.5 mm OD
503374



1:1



Dumont Vessel Cannulation Forceps, Stainless Steel

Length 13cm
Cannulation 0.35 mm OD
503373



Dumont Vessel Cannulation Forceps, Stainless Steel

Length 13cm
Cannulation 1.0 mm OD
503375

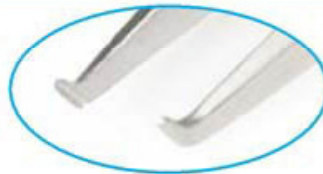

Vessel cannulation forceps are designed to insert small catheters into vessels. The small hollow jaws of the forceps ensure a secure insertion without damaging the fine tubes.



Ajmo Star Surgico

Showali(East.) P.O. Cantt Sialkot-51310, Pakistan

Tel: +92 52 4273146 Fax: +92 52 4298566 Email: info@ajmostar.com, sales@ajmostar.com

Dumont #5, Titanium
14096
Length 11 cm (4.3 in.)
Tips 0.1 x 0.06 mm

Tip Profile: ▲



1:1

Dumont #55, Dumostar Steel, non-magnetic, non-corrosive
500235
Length 11 cm (4.3 in.)
Tips 0.05 x 0.01 mm

Tip Profile: ▲



1:1

Dumont #55, Stainless Steel
14099
Length 11 cm (4.3 in.)
Tips 0.05 x 0.01 mm

Tip Profile: ▲



1:1

Dumont #5B, Stainless Steel
500234
Length 11 cm (4.3 in.)
Tips 0.05 x 0.01 mm, bent 45°

Tip Profile: ▲



1:1

Dumont #6, Stainless Steel
501204
Length 12 cm (4.75 in.)
Tips 0.17 x 0.1 mm, sharp points

Tip Profile: ▲



1:1

Dumont #7, Dumoxel Steel, non-magnetic
14188
Length 12 cm (4.75 in.)
Tips 0.17 x 0.1 mm, curved

Tip Profile: ▲



1:1

Dumont #7, Stainless Steel
14097
Length 12 cm (4.75 in.)
Tips 0.17 x 0.1 mm, curved

Tip Profile: ▲



1:1

Dumont #7, Titanium
14187
Length 12 cm (4.75 in.)
Tips 0.17 x 0.1 mm, curved

Tip Profile: ▲



1:1

Dumont #7, Stainless Steel
501302
Length 11 cm (4.3 in.)
Tips 0.17 x 0.1 mm, curved, serrated jaws

Tip Profile: ▲



1:1

Dumont #7, Stainless Steel, self-closing
501205
Length 12 cm (4.75 in.)
Tips 0.07 x 0.03 mm, curved

Tip Profile: ▲



1:1



Ajmo Star Surgico

Showali(East.) P.O. Cantt Sialkot-51310, Pakistan

Tel: +92 52 4273146 Fax: +92 52 4298566 Email: info@ajmostar.com, sales@ajmostar.com

Dumont #2, Dumoxel Steel, non-magnetic

	503366
Length	7 cm (2.75 in.)
Tips	10 x 0.17 mm



1:1

Dumont #M35A, Dumoxel Steel, non-magnetic

	503368
Length	7 cm (2.75 in.)
Tips	0.04 x 0.08 mm



1:1

Dumont #M4S, Dumoxel Steel, non-magnetic

	503367
Length	7 cm (2.75 in.)
Tips	0.08 x 0.17 mm



1:1

Dumont #5, Stainless Steel

	14095
Length	11 cm (4.3 in.)
Tips	0.05 x 0.01 mm



1:1

Tip Profile: ▲

Dumont #5, Dumoxel Steel, self-closing

	501203
Length	11 cm (4.3 in.)
Tips	0.1 x 0.06 mm



1:1

Tip Profile: ▲

Dumont #5, Stainless Steel, self-closing

	501202
Length	11 cm (4.3 in.)
Tips	0.05 x 0.01 mm



1:1

Tip Profile: ▲

Dumont #5, Stainless Steel

	501201
Length	11 cm (4.3 in.)
Tips	0.05 x 0.01 mm, bent 90°



1:1

Tip Profile: ▲

Dumont #5, Stainless Steel

	14101
Length	11 cm (4.3 in.)
Tips	0.05 x 0.01 mm, bent 45°



1:1

Tip Profile: ▲

Dumont #5, Stainless Steel

	500232
Length	11 cm (4.3 in.)
Tips	0.02 x 0.06 mm half curved



1:1

Tip Profile: ▲



Ajmo Star Surgico

Showali(East.) P.O. Cantt Sialkot-51310, Pakistan

Tel: +92 52 4273146 Fax: +92 52 4298566 Email: info@ajmostar.com, sales@ajmostar.com

Dumont #3, Dumostar Steel, non-magnetic, non-corrosive

	500337
Length	12 cm (4.75 in.)
Tips	0.08 x 0.04 mm



Dumont #3, Stainless Steel

	500338
Length	12 cm (4.75 in.)
Tips	0.17 x 0.10 mm



Dumont #3, Stainless Steel

	503235
Length	12 cm (4.75 in.)
Tips	0.20 x 0.12 mm



Dumont #4, Dumostar Steel, non-magnetic, non-corrosive

	500339
Length	11 cm (4.3 in.)
Tips	0.06 x 0.02 mm



Dumont #4, Stainless Steel

	500340
Length	11 cm (4.3 in.)
Tips	0.13 x 0.08 mm



Dumont #4, Stainless Steel

	500231
Length	11 cm (4.3 in.)
Tips	0.02 x 0.06 mm



Dumont #5, Dumostar Steel, non-magnetic, non-corrosive

	500085
Length	11 cm (4.3 in.)
Tips	0.025 x 0.015 mm



Dumont #5, Dumostar Steel, non-magnetic, non-corrosive

	500233
Length	11 cm (4.3 in.)
Tips	0.1 x 0.06 mm



Dumont #5, Dumoxel Steel, non-magnetic

	14098
Length	11 cm (4.3 in.)
Tips	0.1 x 0.06 mm

Dumont #5, Stainless Steel

	501985	500341	500342
Length	11 cm (4.3 in.)	0.10 x 0.06 mm	0.10 x 0.06 mm
Tips	0.025 x 0.005 mm	0.05 x 0.01 mm	0.10 x 0.06 mm



Ajmo Star Surgico

Showali(East.) P.O. Cantt Sialkot-51310, Pakistan

Tel: +92 52 4273146 Fax: +92 52 4298566 Email: info@ajmostar.com, sales@ajmostar.com

Forceps by Dumont

Mini Dumont #M5S, Stainless Steel

	501764
Length	8.2 cm (3.25 in.)
Tips	0.09 x 0.05 mm



1:1

Dumont #1, Stainless Steel

	500335
Length	12 cm (4.75 in.)
Tips	0.20 x 0.12 mm



1:1

Tip Profile: ▲

Dumont #1, Stainless Steel

	500229
Length	12 cm (4.75 in.)
Tips	0.1 x 0.06 mm



1:1

Tip Profile: ▲

Dumont #2, Stainless Steel

	500336
Length	12 cm (4.75 in.)
Tips	0.34 x 0.14 mm



1:1

Tip Profile: ■

Dumont #2, Stainless Steel

	500230
Length	12 cm (4.75 in.)
Tips	0.17 x 0.07 mm



1:1

Tip Profile: ■

Dumont #3C, Dumostar Steel, non-magnetic, non-corrosive

	500064
Length	11 cm (4.3 in.)
Tips	0.08 x 0.04 mm



1:1

Tip Profile: ▲

What type of alloy to chose for your application?

	Hardness (Rockwell)	Max. Temp. Resistance	Corrosion Resistance	Magnetic
Stainless Steel	55-56	350°C	Good	Yes
Stainless Steel is also known as Inox (from French <i>acier inoxydable</i> , a synonym for stainless steel). For general purpose use. Good resistance to corrosion. Magnetic. Autoclavable.				
Dumoxel	36	350°C	Excellent	No
Dumont patented steel. Resistant to staining, but slightly softer and less magnetic than stainless steel. Higher resistance to corrosion due to high content of molybdenum and chromium. Very resistant to sulfuric acid, hydrochloric acid and other mineral and organic acids. Autoclavable. More likely to bend than to break. Non-magnetic.				
Dumostar	62	550°C	100% Non-corrosive	No
Dumont patented steel. Highly resistant to metal fatigue, has great elasticity, and is durable. Resistant to mineral and organic acids, salt. Autoclavable. More likely to break than to bend. Non-magnetic.				
Titanium	37	550°C	100% Non-corrosive	No
Completely stain-free, 40% lighter than regular stainless steel, completely non-magnetic, but is also the softest alloy. Can be used on corrosive environment. Autoclavable. Non magnetic.				



Ajmo Star Surgico

Showali(East.) P.O. Cantt Sialkot-51310, Pakistan

Tel: +92 52 4273146 Fax: +92 52 4298566 Email: info@ajmostar.com, sales@ajmostar.com

Westcott Stitch Scissors

Length: 115mm long
Tips: 19, curved

Titanium 555541S



Westcott Curved Scissors

Length: 115mm long
Tips: blunt, 21mm, curved

Titanium 555620S



Castroviejo Curved Scissors

Length: 112mm long
Tips: 11mm, blunt

Titanium 555526S



Castroviejo Curved Scissors

Length: 116mm long
Tips: 16mm, blunt

Titanium 555525S



Castroviejo Curved Scissors

Length: 116mm long
Tips: strong curve

Titanium 555523S



Iris Scissors

Length: 11cm long
Tips: straight pointed, 32mm

Titanium 555646S

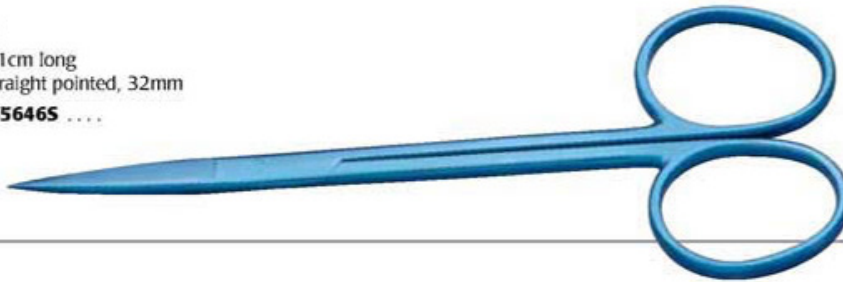

Mayo Harrington Scissors

Titanium

Length: 14.5 cm (5.75 in.)
Tips: straight, 32 mm

555659S



Ajmo Star Surgico

Showali(East.) P.O. Cantt Sialkot-51310, Pakistan

Tel: +92 52 4273146 Fax: +92 52 4298566 Email: info@ajmostar.com, sales@ajmostar.com

Castroviejo Straight Scissors

Length: 105mm long
Tips: 11mm

Titanium 555530S.....



Castroviejo Curved Scissors

Length: 105mm long
Tips: small

Titanium 555524S.....



Mcperson-Westcott Stitch Scissors

Length: 105mm long
Tips: 10.5 long

Titanium 555540S.....



Mcperson-Westcott Scissors

Length: 105mm long
Tips: curved, blunt

Titanium 555500S.....



Iris Scissors

Length: 105mm long
Tips: Sharp, 11mm curved

Titanium 555562S.....



Vannas Scissors

Length: 108mm long
Tips: extra thin 13 mm straight blades, sharp

Titanium 555600S.....



Vannas Scissors

Length: 108mm long
Tips: straight, sharp, 10.5mm

Titanium 555580S.....



Westcott Curved Scissors

Length: 110mm long
Tips: blunt, 19mm, curved

Titanium 555621S.....

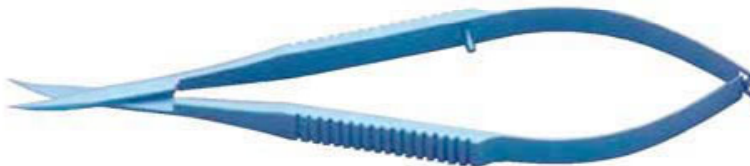

Ajmo Star Surgico

Showali(East.) P.O. Cantt Sialkot-51310, Pakistan

Tel: +92 52 4273146 Fax: +92 52 4298566 Email: info@ajmostar.com, sales@ajmostar.com

Titanium Scissors

- 100% non-corrosive (great for seawater procedures)
- 100% non-magnetic (MRI compatible)
- 40% lighter than stainless steel (reduces hand fatigue)
- Anodized, non-glare blue finish

Vannas Scissors

Length: 8cm long
Tips: straight, 3mm

Titanium 14364.....



Vannas Scissors

Length: 82mm long
Tips: sharp, 9.5 angled to side

Titanium 555647S.....



Vannas Scissors

Length: 82mm long
Tips: sharp tips angled, 9.5mm

Titanium 555641S.....



Vannas Scissors

Length: 82mm long
Tips: sharp tips straight, 9.5mm

Titanium 555640S.....



Iris Scissors

Length: 90mm long
Tips: Sharp, 11mm curved

Titanium 555561S.....



Iris Scissors

Length: 90mm long
Tips: Sharp, 11mm straight

Titanium 555560S.....



Vannas Scissors

Length: 95mm long
Tips: angled sharp, 10.5mm

Titanium 555584S.....



Vannas Capsulotomy Scissors

Length: 95mm long
Tips: curved, sharp, 12.5 mm

Titanium 555583S.....

Tips: curved, sharp, 10.5 mm
Titanium 555582S.....



Ajmo Star Surgico

Showali(East.) P.O. Cantt Sialkot-51310, Pakistan

Tel: +92 52 4273146 Fax: +92 52 4298566 Email: info@ajmostar.com, sales@ajmostar.com

Microintraocular Scissors, Stainless Steel

		TITANIUM handle
	500372	500372-T
Length	14 cm (5.5 in.)	14 cm (5.5 in.)
Blades	30° angled blades	30° angled blades

Tip Profile:



1:1

Microintraocular Scissors, Stainless Steel

	500374
Length	14 cm (5.5 in.)
Blades	35° angled blades

Tip Profile:



1:1

Microintraocular Scissors, Stainless Steel

	500376
Length	14 cm (5.5 in.)
Blades	90° angled blades

Tip Profile:



1:1

MiniDissecting, Left Hand
9 cm long, curved, stainless steel
503626



MiniDissecting, Left Hand
9 cm long, curved, fine tips, stainless steel
503627



9 cm long, straight, stainless steel
503625



9 cm long, straight, fine tips, stainless steel
503628



LEFTIES!



Ajmo Star Surgico

Showali(East.) P.O. Cantt Sialkot-51310, Pakistan

Tel: +92 52 4273146 Fax: +92 52 4298566 Email: info@ajmostar.com, sales@ajmostar.com

Roger Wirecutting Scissors, Stainless Steel

	Standard	German
	501321	501321-G
Length	12 cm (4.75 in.)	12 cm (4.75 in.)
Blades	notched blade	notched blade



1:1

Tip Profile:



Utility Scissors

	Standard	German
	501322	501322-G
Length	14 cm (5.5 in.)	14 cm (5.5 in.)
Blades	angled	angled



1:1

Variety of colored handles available!

Scissors, Round Handled, Stainless Steel

	14208
Length	14 cm (5.5 in.)
	Round hollow handles
Blades	Curved



1:1

Tip Profile:



Scissors, Round Handled, Stainless Steel

	14212
Length	14 cm (5.5 in.)
	Round hollow handles
Blades	Straight



1:1



Ajmo Star Surgico

Showali(East.) P.O. Cantt Sialkot-51310, Pakistan

Tel: +92 52 4273146 Fax: +92 52 4298566 Email: info@ajmostar.com, sales@ajmostar.com

Mayo Scissors, SuperCut Stainless Steel, Tungsten Carbide Blades

These are the finest scissors available. They combine the precise cutting action of the razor-sharp SuperCut blades with the durability of Tungsten Carbide. They will provide a clean, smooth cut and retain their sharpness for an extended period of time.



	Standard	German	Standard	German
	501259	501259-G	501260	501260-G
Length	17 cm (6.75 in.)	17 cm (6.75 in.)	17 cm (6.75 in.)	17 cm (6.75 in.)
Blades	straight	straight	curved	curved
Tips	5.5 mm tips	5.5 mm tips	5.5 mm tips	5.5 mm tips

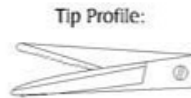

Plastic Surgery Scissors, Stainless Steel

	503247
Length	11cm (4.3 in.)
Blades	Curved
Tips	sharp/sharp

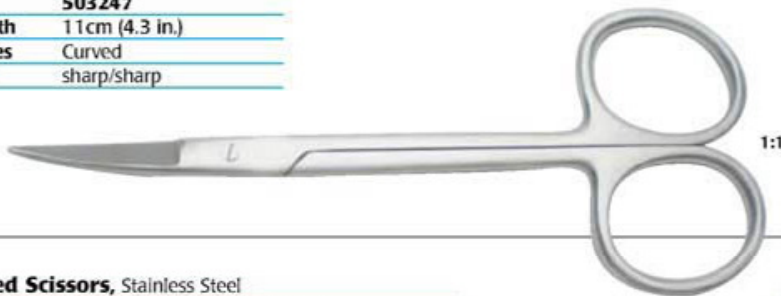

Angled Scissors, Stainless Steel

	Standard	German
	500047	500047-G
Length	14 cm (5.5 in.)	14 cm (5.5 in.)
Blades	30° angled to side	30° angled to side
Tips	sharp/sharp	sharp/sharp



Angled Scissors, Stainless Steel

	503225
Length	11cm (4.3 in.)
Blades	35° angled to side, serrated
Tips	sharp/sharp

Spencer Stitch Scissors, Stainless Steel

	Standard	German
	500380	500380-G
	9 cm (3.5 in.) long	
	501703	501703-G
	10.75 cm (4.25 in.) long	
	501704	501704-G
	13.25 cm (5.5 in.) long	



Lister Bandage Scissors, Stainless Steel

	Standard	German
	500444	500444-G
	15 cm (6 in.) long, 4cm long blades	
	501701	501701-G
	8.75 cm (3.5 in.) long	
	501702	501702-G
	10.75 cm (4.25 in.) long	
	555656S	15 cm (6 in.) long Titanium



Ajmo Star Surgico

Showali(East.) P.O. Cantt Sialkot-51310, Pakistan

Tel: +92 52 4273146 Fax: +92 52 4298566 Email: info@ajmostar.com, sales@ajmostar.com

Operating Scissors

		<i>Standard</i>	<i>German</i>
11.5 cm (4.5 in.) Straight	Sharp/Blunt	501753	501753-G
	Sharp/Sharp	501754	501754-G
	Blunt/Blunt	501743	501743-G
11.5 cm (4.5 in.) Curved	Sharp/Sharp	501755	501755-G
	Sharp/Blunt	501756	501756-G
	Blunt/Blunt	501757	501757-G
14 cm (5.5 in.) Curved	Sharp/Sharp	501220	501220-G
	Sharp/Blunt	501221	501221-G
	Blunt/Blunt	501222	501222-G
14 cm (5.5 in.) Straight	Sharp/Blunt	14192	14192-G
	Sharp/Sharp	501218	501218-G
	Blunt/Blunt	501219	501219-G

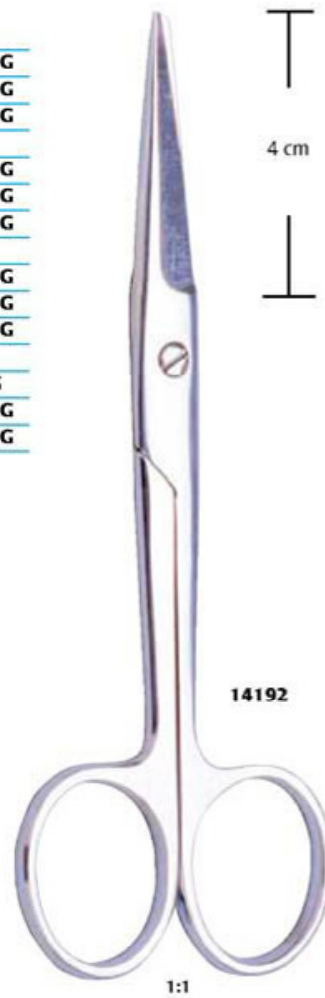
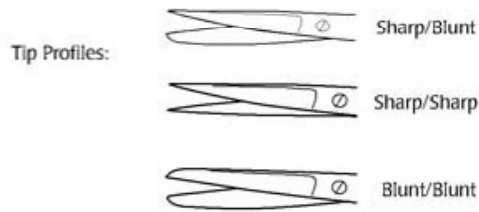

		<i>Standard</i>	<i>German</i>
16 cm (6.25 in.) Straight	Sharp/Blunt	501223	501223-G
	Blunt/Blunt	501224	501224-G
	Sharp/Sharp	501225	501225-G
16 cm (6.25 in.) Curved	Sharp/Blunt	501226	501226-G
	Blunt/Blunt	501227	501227-G
	Sharp/Sharp	501228	501228-G
18 cm (7 in.) Straight	Sharp/Sharp	15924	15924-G
	Sharp/Blunt	500378	500378-G
	Blunt/Blunt	500379	500379-G
18 cm (7 in.) Curved	Sharp/Blunt	501229	501229-G
	Blunt/Blunt	501230	501230-G
	Sharp/Sharp	501231	501231-G



Ajmo Star Surgico

Showali(East.) P.O. Cantt Sialkot-51310, Pakistan

Tel: +92 52 4273146 Fax: +92 52 4298566 Email: info@ajmostar.com, sales@ajmostar.com

Metzenbaum Scissors, SuperCut Stainless Steel, **Tungsten Carbide** Blades

These are the finest scissors available. They combine the precise cutting action of the razor-sharp SuperCut blades with the durability of

Tungsten Carbide. They will provide a clean, smooth cut and retain their sharpness for an extended period of time.

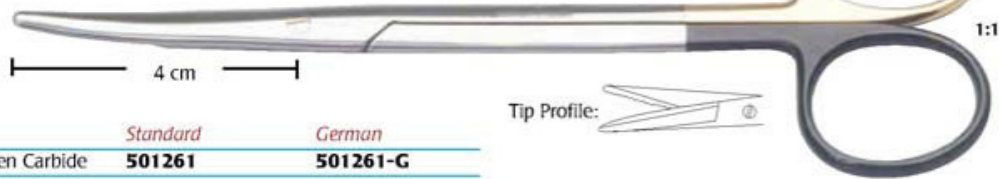

		Standard	German
15 cm (5.9 in.)	Curved, Tungsten Carbide	501261	501261-G
	Straight, Tungsten Carbide		503359-G
18 cm (7 in.)	Curved, Tungsten Carbide	501262	501262-G

Mayo Scissors, Stainless Steel

		Standard	German
14 cm (5.5 in.)	Straight	501749	501749-G
	Curved	501750	501750-G

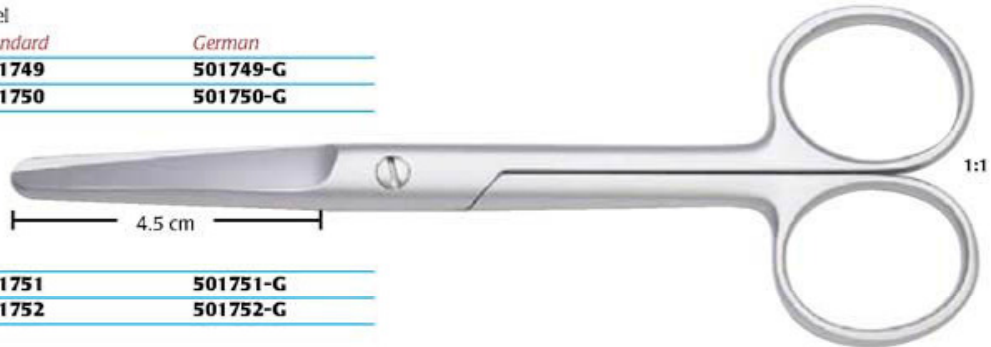

17 cm (6.75 in.)	Straight	501751	501751-G
	Curved	501752	501752-G

Mayo Scissors, Stainless Steel, **Tungsten Carbide** Blades

		Standard	German
14 cm (5.5 in.)	Straight	500218	500218-G
	Curved	500219	500219-G
17.5 cm (7 in.)	Straight	500220	500220-G
	Curved	500221	500221-G

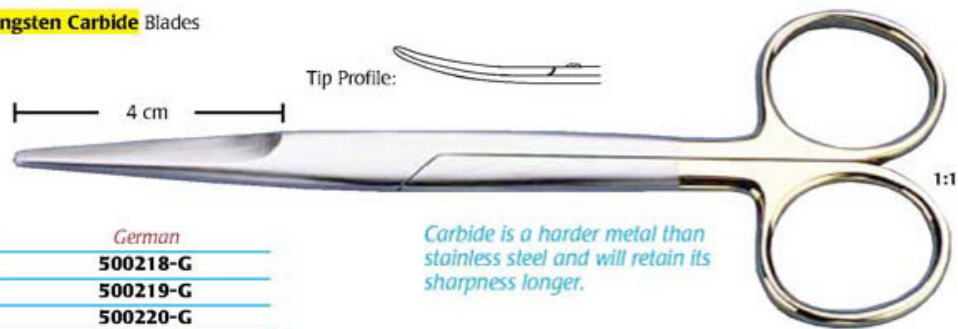

Carbide is a harder metal than stainless steel and will retain its sharpness longer.

Mayo Scissors, SuperCut, Stainless Steel

One edge micro serrated, one edge honed to the sharpness of a knife edge

		Standard	German
14 cm (5.5 in.)	Straight	14216	14216-G
	Curved	14217	14217-G

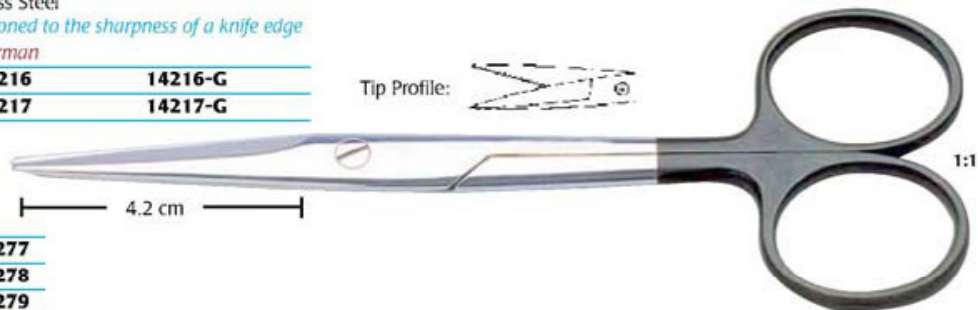

16 cm (6.3 in.)	Straight	503277
	Curved	503278
20 cm (7.8 in.)	Straight	503279
	Curved	503280
25 cm (9.8 in.)	Straight	503281
	Curved	503282

Also in Titanium

17 cm long (6.75 in.)	Supercut, Straight Tip	503384
17 cm long (6.75 in.)	Supercut, Curved Tip	503385

Surgical Instruments - www.ajmostar.com



Ajmo Star Surgico

Showali(East.) P.O. Cantt Sialkot-51310, Pakistan

Tel: +92 52 4273146 Fax: +92 52 4298566 Email: info@ajmostar.com, sales@ajmostar.com

Tenotomy Scissors, Stainless Steel

		Standard	German
12.5 cm (5 in.)	Straight	14220	14220-G
	Curved	14221	14221-G
14 cm (5.5 in.)	Straight	503265	
	Curved	503266	
16 cm (6.2 in.)	Straight	503267	
	Curved	503268	

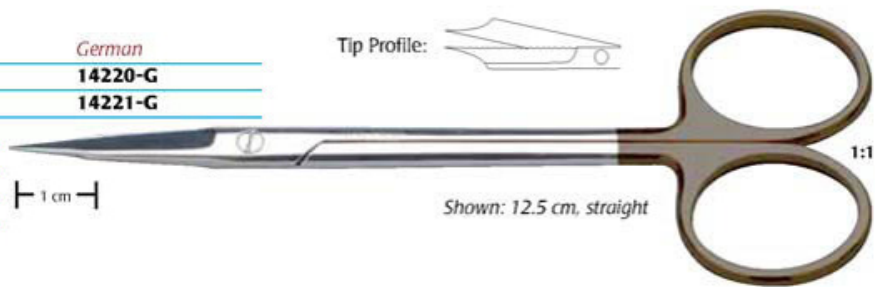

Shown: 12.5 cm, straight

Tenotomy Scissors, SuperCut, Stainless Steel

One edge micro serrated, one edge honed to the sharpness of a knife edge

		Standard	German
10 cm (4 in.)	Straight	14395	14395-G
	Curved	14396	14396-G
11.5 cm (4.5 in.)	Straight	503263	
	Curved	503264	

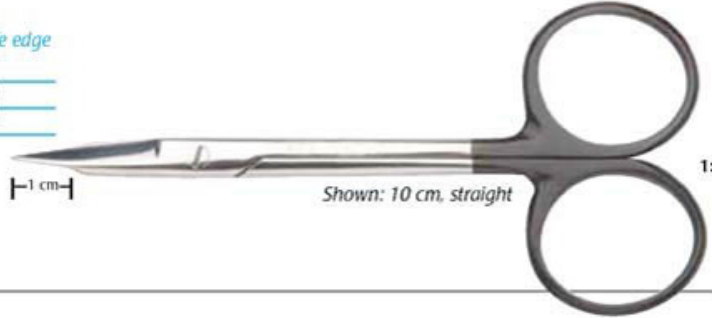

Shown: 10 cm, straight

Metzenbaum Scissors, Stainless Steel

		Standard	German
11.5 cm (4.5 in.)	Straight	501747	501747-G
	Curved	501748	501748-G
14.5 cm (5.75 in.)	Straight	501252	501252-G
	Curved	501253	501253-G



17.5 cm (7 in.)	Straight	501254	501254-G
	Curved	501255	501255-G

Metzenbaum Scissors, Stainless Steel, Tungsten Carbide Blades

		Standard	German
11.5 cm (4.5 in.)	Straight, Tungsten Carbide	501739	501739-G
	Curved, Tungsten Carbide	501740	501740-G

Carbide is a harder metal than stainless steel and will retain its sharpness longer.



Shown: 14.5 cm, straight

14.5 cm (5.75 in.)	Straight, Tungsten Carbide	501733	501733-G
	Curved, Tungsten Carbide	501734	501734-G
18 cm (7 in.)	Straight, Tungsten Carbide	501744	501744-G
	Curved, Tungsten Carbide	501745	501745-G

Metzenbaum Scissors, SuperCut, Stainless Steel

		Standard	German
11.5 cm (4.5 in.)	Straight	503269	
	Curved	503270	
12.5 cm (5 in.)	Straight	14214	14214-G
	Curved	14215	14215-G
16 cm (6.2 in.)	Straight	503271	
	Curved	503272	
20 cm (7.75 in.)	Straight	503273	
	Curved	503274	
25 cm (9.75 in.)	Straight	503275	
	Curved	503276	

Also in Titanium

14cm long (5.5 in.), curved tip	503383
14cm long (5.5 in.), straight tip	503382

One edge micro serrated, one edge honed to the sharpness of a knife edge

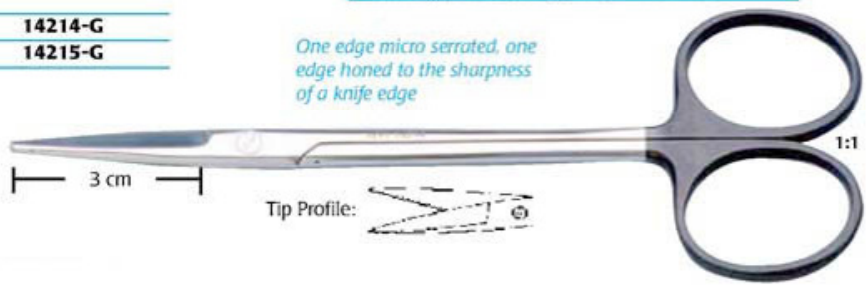

Ajmo Star Surgico

Showali(East.) P.O. Cantt Sialkot-51310, Pakistan

Tel: +92 52 4273146 Fax: +92 52 4298566 Email: info@ajmostar.com, sales@ajmostar.com

Iris Scissors, SuperCut, Stainless Steel
One edge micro serrated, one edge honed to the sharpness of a knife edge

Standard	German
14218 10 cm (4 in.), Straight	14218-G
14219 10 cm (4 in.), Curved	14219-G
503259 11.5 cm (4.5 in.), Straight	
503260 11.5 cm (4.5 in.), Curved	

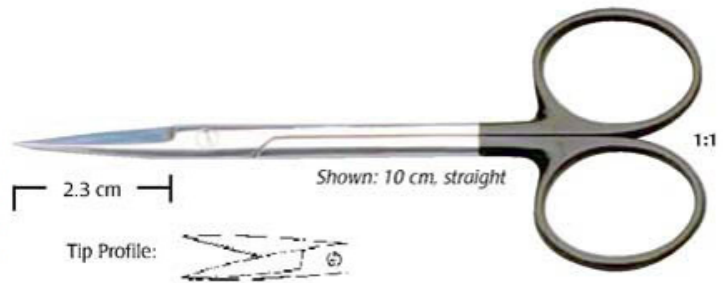

Iris Scissors, SuperCut, Stainless Steel
One edge micro serrated, one edge honed to the sharpness of a knife edge

Standard	German
14225 12.5 cm (5 in.), Straight	14225-G
14224 12.5 cm (5 in.), Curved	14224-G
503261 14 cm (5.5 in.), Straight	
503262 14 cm (5.5 in.), Straight	



Iris Scissors, SuperCut, Stainless Steel, Tungsten Carbide Blades

Standard	German
501263	501263-G
Length 11 cm (4.3 in.)	11 cm (4.3 in.)
Blades Straight	Straight
501264	501264-G
Length 11 cm (4.3 in.)	11 cm (4.3 in.)
Blades Curved	Curved

These are the finest scissors available. They combine the precise cutting action of the razor-sharp SuperCut blades with the durability of **Tungsten Carbide**. They will provide a clean, smooth cut and retain their sharpness for an extended period of time.

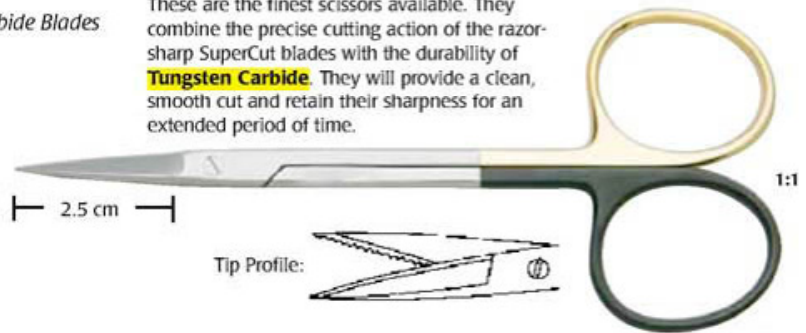

Ribbon Handle Iris Scissors, Stainless Steel

501767	501768
Length 11 cm (4.3 in.)	11 cm (4.3 in.)
Blades Straight	Curved

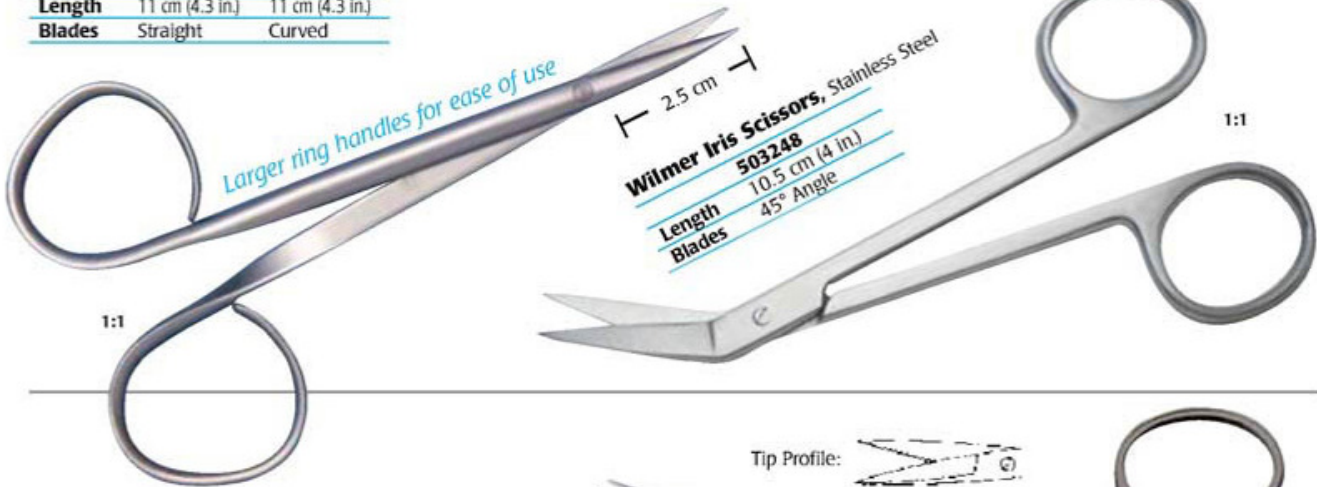

Wilmer Iris Scissors, Stainless Steel
503248
 Length 10.5 cm (4 in.)
 Blades 45° Angle

Iris Scissors, SuperCut Angled, Stainless Steel

500046
Length 10cm (3.9 in.)
Blades 30° angled to side



Ajmo Star Surgico

Showali(East.) P.O. Cantt Sialkot-51310, Pakistan

Tel: +92 52 4273146 Fax: +92 52 4298566 Email: info@ajmostar.com, sales@ajmostar.com

Mini Dissecting Scissors, stainless steel

503666	8.5 cm (3.3 in.) curved, sharp tips
503667	8.5 cm (3.3 in.) straight, sharp tips
503668	8.5 cm (3.3 in.) curved, blunt tips
503669	8.5 cm (3.3 in.) straight, blunt tips

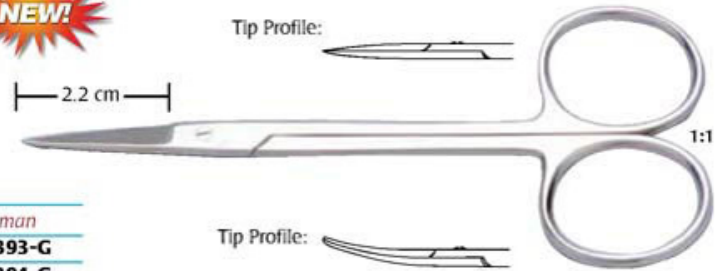

Dissecting Scissors, stainless steel

Standard		German	
14393	10 cm (4 in.) straight tips	14393-G	
14394	10 cm (4 in.) curved tips	14394-G	
15922	12.5 cm (5 in.) straight tips	15922-G	
15923	12.5 cm (5 in.) curved tips	15923-G	

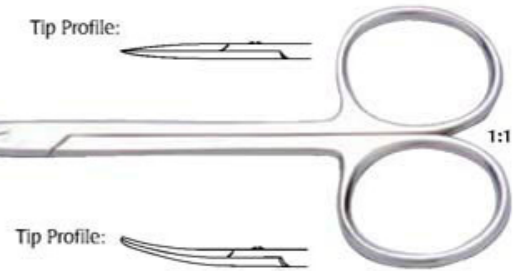

Iris Scissors, Stainless Steel

	Standard	German
	500216	500216-G
Length	11.5 cm (4.5 in.)	11.5 cm (4.5 in.)
Blades	Straight, Tungsten Carbide	Straight, Tungsten Carbide
	500217	500217-G
Length	11.5 cm (4.5 in.)	11.5 cm (4.5 in.)
Blades	Curved, Tungsten Carbide	Curved, Tungsten Carbide

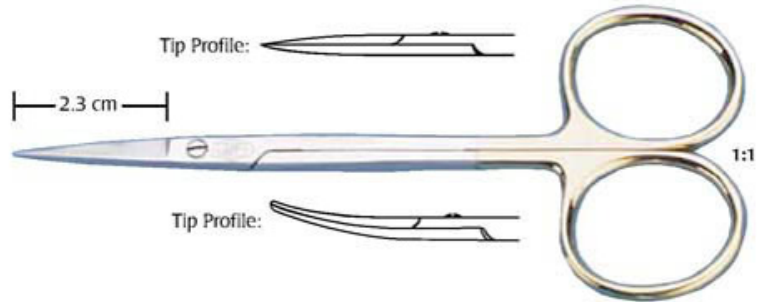

Dissecting Scissors, Stainless Steel

	Standard	German
	500366	500366-G
Length	10 cm (4 in.)	10 cm (4 in.)
Blades	Straight, Blunt Probe Tips	Straight, Blunt Probe Tips
	500367	500367-G
Length	10 cm (4 in.)	10 cm (4 in.)
Blades	Curved, Blunt Probe Tips	Curved, Blunt Probe Tips

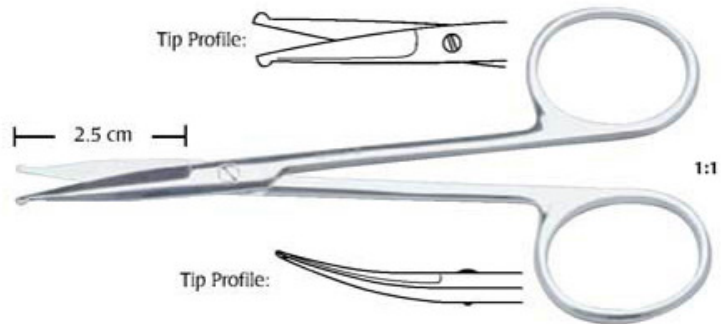

Iris Scissors, Stainless Steel

	Standard	German
501758	11 cm (4.3 in.), straight	501758-G
501759	11 cm (4.3 in.), curved	501759-G
503225	11 cm (4.3 in.), 45° angled serrated tip	
503224	11 cm (4.3 in.), 35° angled serrated tip	

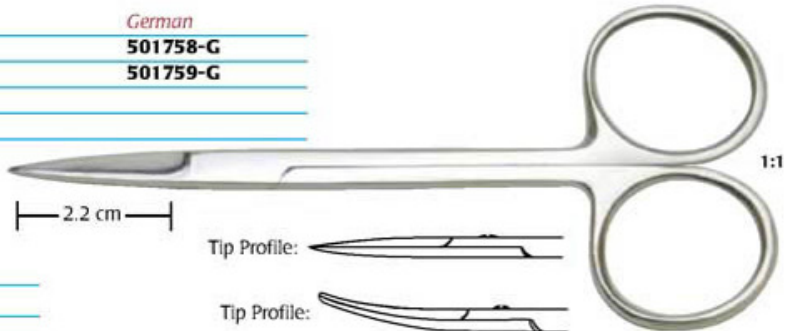

Mini-Iris Scissors, Stainless Steel

503670	8 cm (3.1 in.) straight, sharp tips
503671	8 cm (3.1 in.) curved, sharp tips

Barraquer Iris Scissors, Stainless Steel

	Standard	German
	14128	14128-G
Length	6 cm (2.5 in.)	6 cm (2.5 in.)
Blades	7 mm, sharp points	7 mm, sharp points



Ajmo Star Surgico Showali(East.) P.O. Cantt Sialkot-51310, Pakistan

Tel: +92 52 4273146 Fax: +92 52 4298566 Email: info@ajmostar.com, sales@ajmostar.com



Mini Dissecting Scissors, Stainless Steel
503243
Length 9.5 cm (3.75 in.)
Blades Sharp medium tips



Mini Dissecting Scissors, Stainless Steel
503241
Length 9.5 cm (3.75 in.)
Blades Sharp fine tips



Mini Dissecting Scissors, Stainless Steel
503240
Length 9.5 cm (3.75 in.)
Blades Regular tips, curved

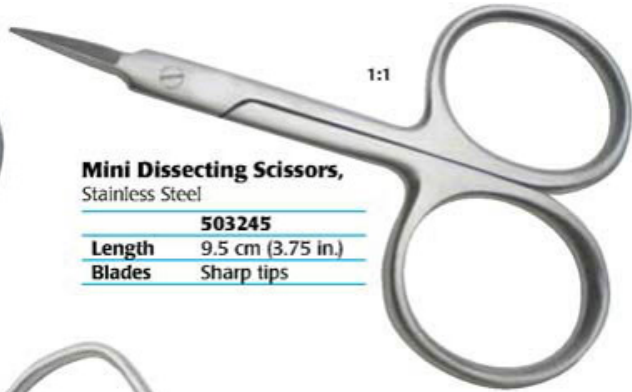

Mini Dissecting Scissors, Stainless Steel
503245
Length 9.5 cm (3.75 in.)
Blades Sharp tips



La Grange Scissors, Stainless Steel
503246
Length 11 cm (4.3 in.)
Blades S-shaped



Miniature Dissecting Scissors, Stainless Steel
503242
Length 9.5 cm (3.75 in.), square handle
Blades Sharp fine tips

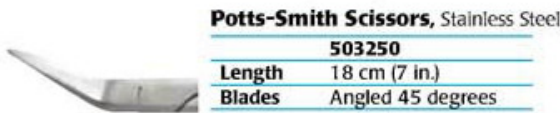

Potts-Smith Scissors, Stainless Steel
503250
Length 18 cm (7 in.)
Blades Angled 45 degrees

Potts-Smith Scissors, Stainless Steel
503251
Length 18 cm (7 in.)
Blades Angled 60 degrees



Potts-Smith Scissors, Stainless Steel
503249
Length 18 cm (7 in.)
Blades Angled 25 degrees



Miniature Dissecting Scissors, Stainless Steel
503244
Length 9.5 cm (3.75 in.)
Blades Round tips, square handle



Tip Profile: 

Spring Scissors, round handles, Stainless Steel

	Standard	German
	14112	14112-G
Length	14 cm (5.5 in.)	14 cm (5.5 in.)
Blades	curved 7 mm	curved 7 mm



Standard and German versions may differ slightly in appearance.

Spring Scissors, round handles, Stainless Steel

	Standard	German
	14111	14111-G
Length	14 cm (5.5 in.)	14 cm (5.5 in.)
Blades	straight 6.5 mm	straight 6.5 mm



Standard and German versions may differ slightly in appearance.

Biemer Scissors, Stainless Steel

	500381
Length	13 cm (5 in.)
Blades	straight

Tip Profile: 



Cuts vessels perpendicularly and without slipping.

Ring Scissors

Goldman-Fox Scissors, Stainless Steel

	503256
Length	13 cm (5 in.)
Blades	Curved, serrated tips

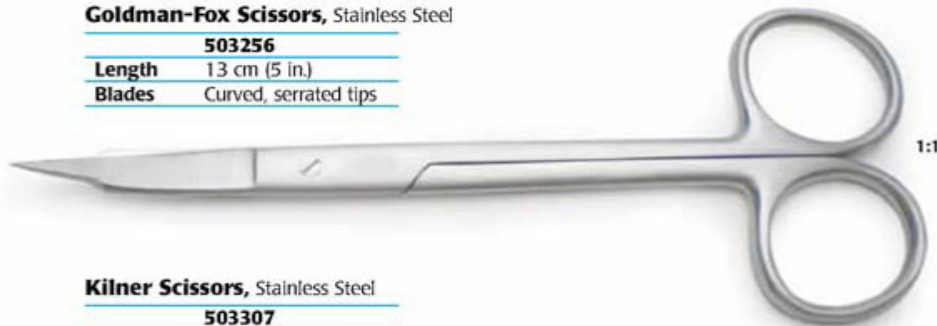

Kilner Scissors, Stainless Steel

	503307
Length	14 cm (5.5 in.)
Blades	Curved, flat tips



Ajmo Star Surgico

Showali(East.) P.O. Cantt Sialkot-51310, Pakistan

Tel: +92 52 4273146 Fax: +92 52 4298566 Email: info@ajmostar.com, sales@ajmostar.com

Student Spring Scissors, blunt/blunt tips, Stainless Steel

	503309	
Length	9.5 cm (3.7 in.)	
Blades	straight, 6 mm	



1:1

Student Spring Scissors, sharp/ball tips, Stainless Steel

	503310	503308
Length	9.5 cm (3.7 in.)	9.5 cm (3.7 in.)
Blades	straight, 6 mm	curved, 6 mm



1:1

Westcott Student Scissors, Stainless Steel

	503222	503223
Length	11 cm (4.3 in.)	11 cm (4.3 in.)
Blades	blunt tips	sharp tips



1:1

McPherson-Westcott Conjunctiva Scissors, Stainless Steel

	504023	
Length	11 cm (4.3 in.)	
Blades	curved, blunt, 9 mm	



1:1

Katena-Vannas Scissors, Stainless Steel

	504024	504025
Length	11 cm (4.3 in.)	11 cm (4.3 in.)
Blades	straight, thin, 7 mm	curved, thin, 7 mm



1:1

Katena-Vannas Scissors, Stainless Steel

	504026	504027
Length	11 cm (4.3 in.)	11 cm (4.3 in.)
Blades	straight, thin, 10mm	curved, thin, 10mm



1:1

Vannas Student Scissors, Stainless Steel

	501777	501930
Length	9 cm (3.5 in.)	9 cm (3.5 in.)
Blades	8 mm long	8 mm long
Tips	500 microns	500 microns



1:1

McPherson Vannas Student Scissors, Stainless Steel

	503749	
Length	8.3 cm (3.25 in.)	
Blades	sharp tips, 8 mm long	



1:1



Ajmo Star Surgico

Showali(East.) P.O. Cantt Sialkot-51310, Pakistan

Tel: +92 52 4273146 Fax: +92 52 4298566 Email: info@ajmostar.com, sales@ajmostar.com

Vannas Tubingen Scissors, German Steel

	503378	503379
Length	8 cm (3 in.)	8 cm (3 in.)
Blades	straight, 3 mm	curved, 3 mm



1:1

Tip Profile:



Spring Scissors, Stainless Steel

	<i>Standard</i>	<i>German</i>	<i>Standard</i>	<i>German</i>
	15905	15905-G	15906	15906-G
Length	14 cm (5.5 in.)	14 cm (5.5 in.)	14 cm (5.5 in.)	14 cm (5.5 in.)
Blades	straight 8 mm	straight 8 mm	curved 8 mm	curved 8 mm

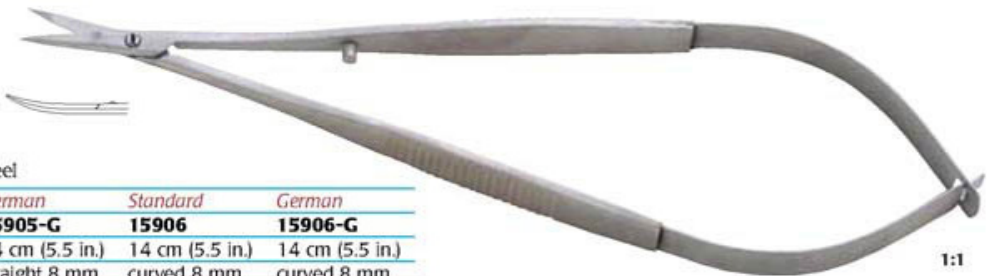

1:1

Standard and German versions may differ slightly in appearance.

*one edge micro serrated,
one edge honed to the
sharpness of a knife edge*

Spring Scissors, SuperCut, Stainless Steel

	501924	501925
Length	12 cm (5 in.)	12 cm (5 in.)
Blades	straight 9mm	curved 9mm



1:1

Tip Profile:



Spring Scissors, Stainless Steel

	<i>Standard</i>	<i>Standard</i>	<i>German</i>
	501235	14127	14127-G
Length	10.5 cm (4 in.)	10.5 cm (4 in.)	10.5 cm (4 in.)
Blades	straight 8 mm	curved 8 mm	curved 8 mm



1:1

Standard and German versions may differ slightly in appearance.

Tip Profile:



Spring Scissors, Stainless Steel

	<i>Standard</i>	<i>German</i>	<i>Standard</i>
	14125	14125-G	14126
Length	12 cm (4.75 in.)	12 cm (4.75 in.)	12 cm (4.75 in.)
Blades	straight 12 mm extra fine and long	straight 12 mm extra fine and long	curved 12 mm extra fine and long



1:1

Standard and German versions may differ slightly in appearance.

Noyes Scissors, sharp/sharp tips

<i>Standard</i>	
500228	12 cm long, straight 15 mm blades
501236	12 cm long, curved 15 mm blades
501237	14 cm long, straight 20 mm blades
501238	14 cm long, curved 20 mm blades
503305	12 cm long, straight, sharp/blunt
503306	12 cm long, straight, blunt/blunt
<i>German</i>	
500228-G	12 cm long, straight 15 mm blades
501236-G	12 cm long, curved 15 mm blades



1:1



Ajmo Star Surgico

Showali(East.) P.O. Cantt Sialkot-51310, Pakistan

Tel: +92 52 4273146 Fax: +92 52 4298566 Email: info@ajmostar.com, sales@ajmostar.com