



AJMO STAR
SURGICO



Laryngoscope

Ajmo Star Surgico is proudly the most sought after name in the field of Medical Diagnostic Instruments. In order to serve the interest and meet requirement of our customers, we endeavor to best of our abilities to improve our existing line and also introduce new products.

www.ajmostar.com

Sahowali (East) P.O. Cantt Sialkot-51310, Pakistan

Ph: 0092 52 353104 , Fax: 0092 52 353096

E-mail: sales@ajmostar.com E-mail: info@ajmostar.com



AJMO STAR

SURGICO



Products Details

Features

Fully premium quality surgical stainless steel blades AISI 304 Japanese Surgical Stainless Steel
CE marked & are interchangeable with ISO 7376 standards manufactured Fiber Optic Blades and Handles
Smooth edges, rounded tip and high quality surface finish
Removable light guides design allow easier cleaning and extends blade life
Provides with larger 4mm fiber optic bundles for light pass gives true tissue color

Supplied with Halogen/Xenon or LED white bulbs

Three spring ball bearings gives secure fit and firm support

Size

12-0 Miller - Size 0 Neonate

11-01 Macintosh - Size 1 Infant

11-02 Macintosh - Size 2 Child

11-03 Macintosh - Size 3 Medium Adult

11-04 Macintosh - Size 4 Large Adult

22-1 Medium 2x C size batteries

22-2 Small 2x AA size batteries

Fiber Optic Cable

Products Details

Features

Highly flexible smooth tube minimize fibre bundle breakages
Fitting can be made according to your specifications or STORZ, ACMI etc model

Size

Dia - Length
4mm - 1800m
4mm - 2250m
Custom made design can be prepared according to your specifications and requirements

Options

Available in different colors.



Macintosh Blades

CAT#	SIZE	DESCRIPTION	A	B
AS -201-00	0	Neonate	80mm	13mm
AS -201-01	1	Infant	92mm	14mm
AS -201-02	2	Child	100mm	17mm
AS -201-03	3	Adult	130mm	11mm
AS -201-04	5	Large Adult	175mm	14mm

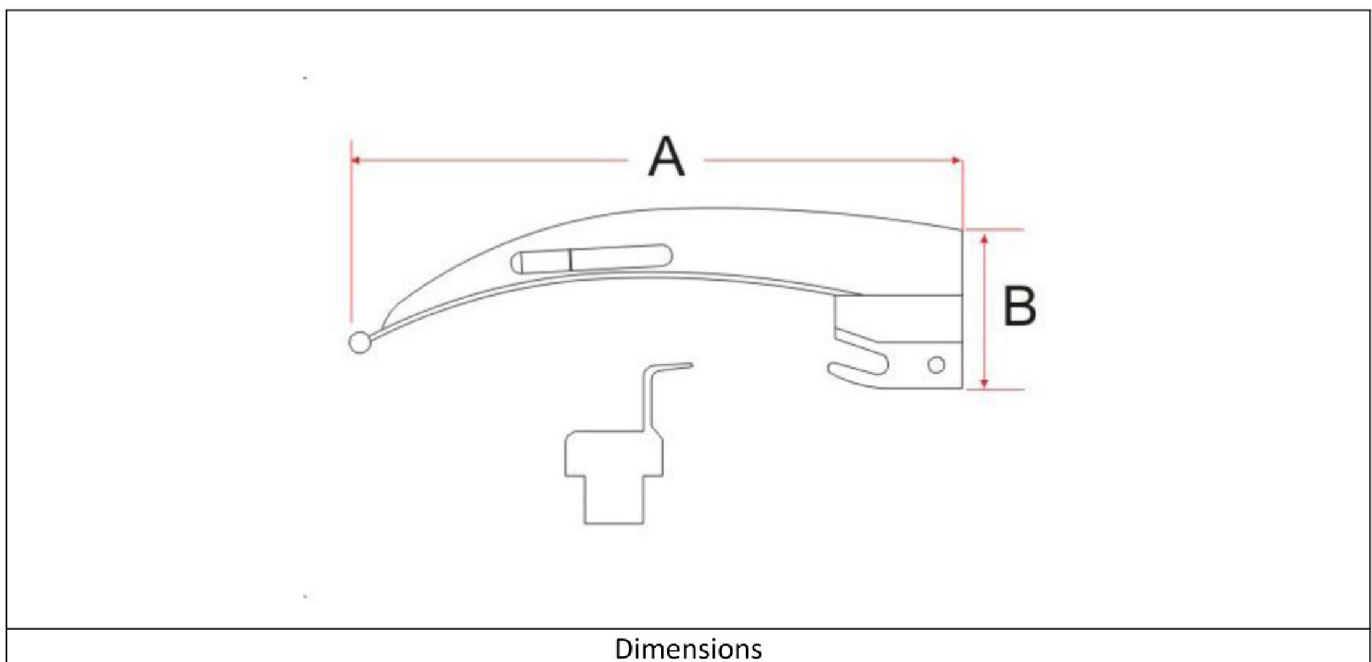

Miller Blades

CAT#	SIZE	DESCRIPTION	A	B
AS -211-00	0	Neonate	75mm	10.5mm
AS -211-01	1	Infant	102mm	10.5mm
AS -211-02	2	Child	153mm	12.5mm
AS -211-03	3	Medium Adult	195mm	11mm
AS -211-04	4	Large Adult	205mm	14mm
AS -211-05	00	Premature	65mm	10.5mm

		
810-211-00	810-211-01	810-211-02
		
810-211-03	810-211-04	810-211-05

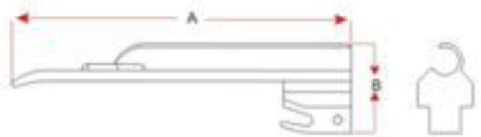
	
833-001-27	Dimension



Wisconsin Blades

CAT#	SIZE	DESCRIPTION	A	B
AS -221-00	0	Neonate	76mm	9.5mm
AS -221-01	1	Infant	102mm	11mm
AS -221-02	2	Child	135mm	15mm
AS -221-03	3	Medium Adult	162mm	16mm
AS -221-04	4	Large Adult	199mm	19mm

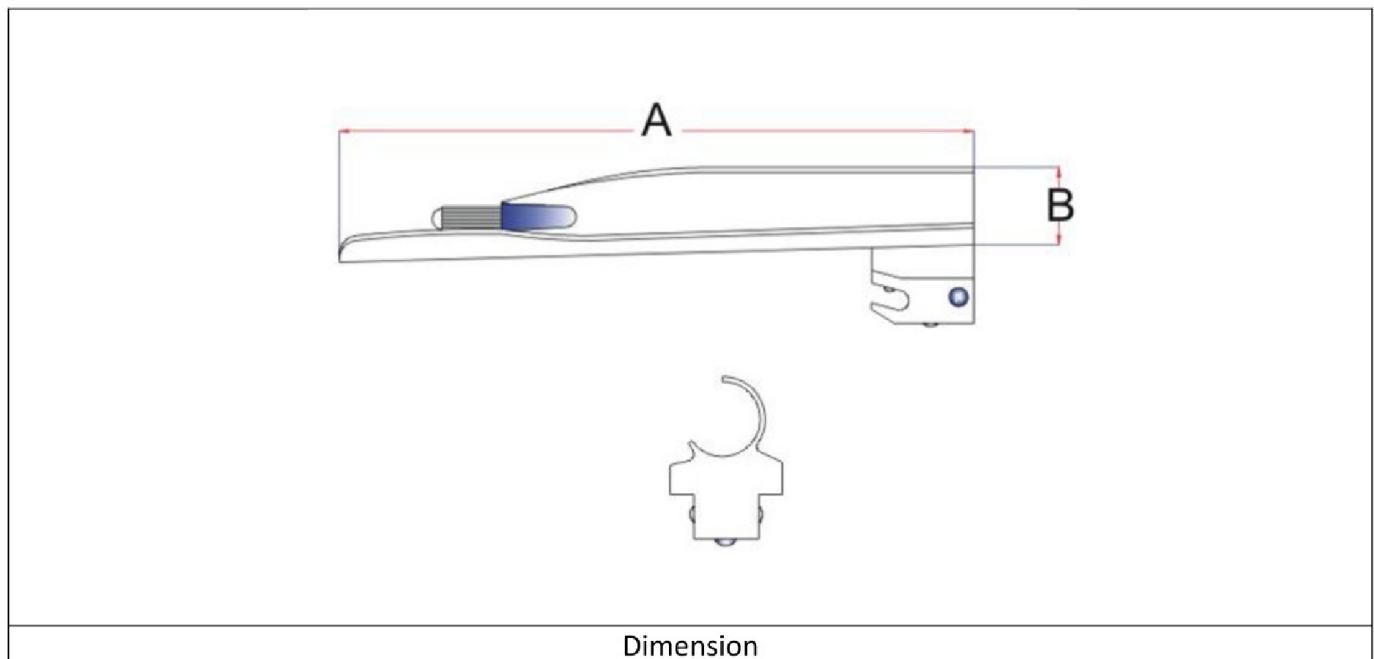

Macinotsh IV Blades

CAT#	SIZE	DESCRIPTION	A	B
AS-241-02	2	Child	100mm	21mm
AS-241-03	3	Medium Adult	130mm	23mm
AS-241-04	4	Large Adult	155mm	26mm

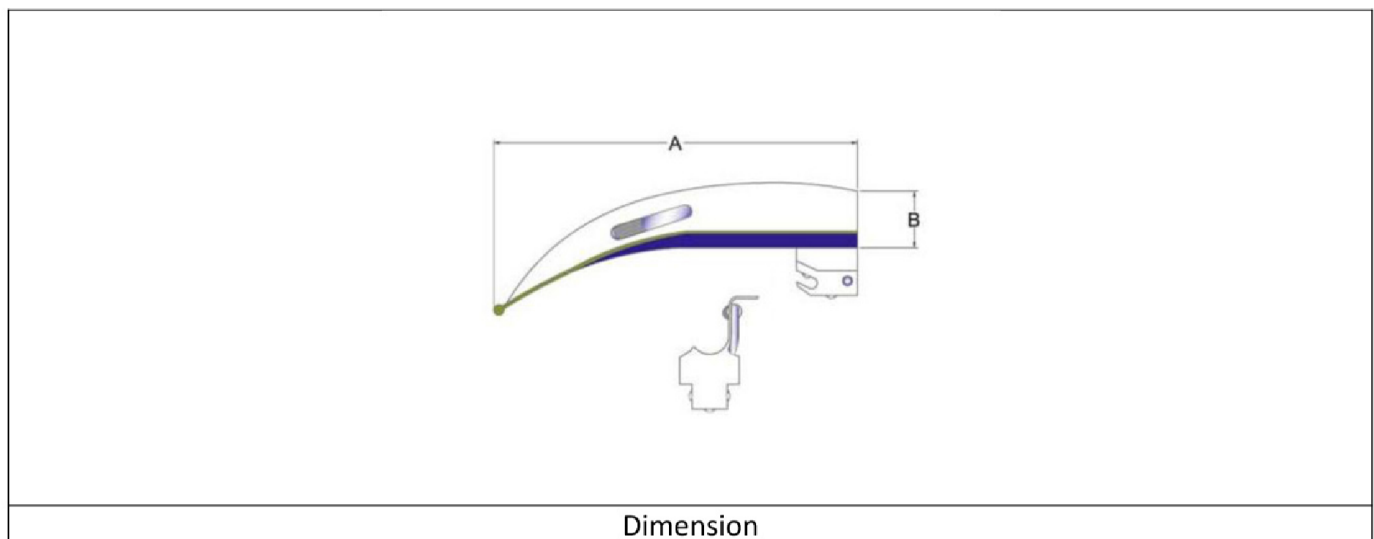



Oxford Blades



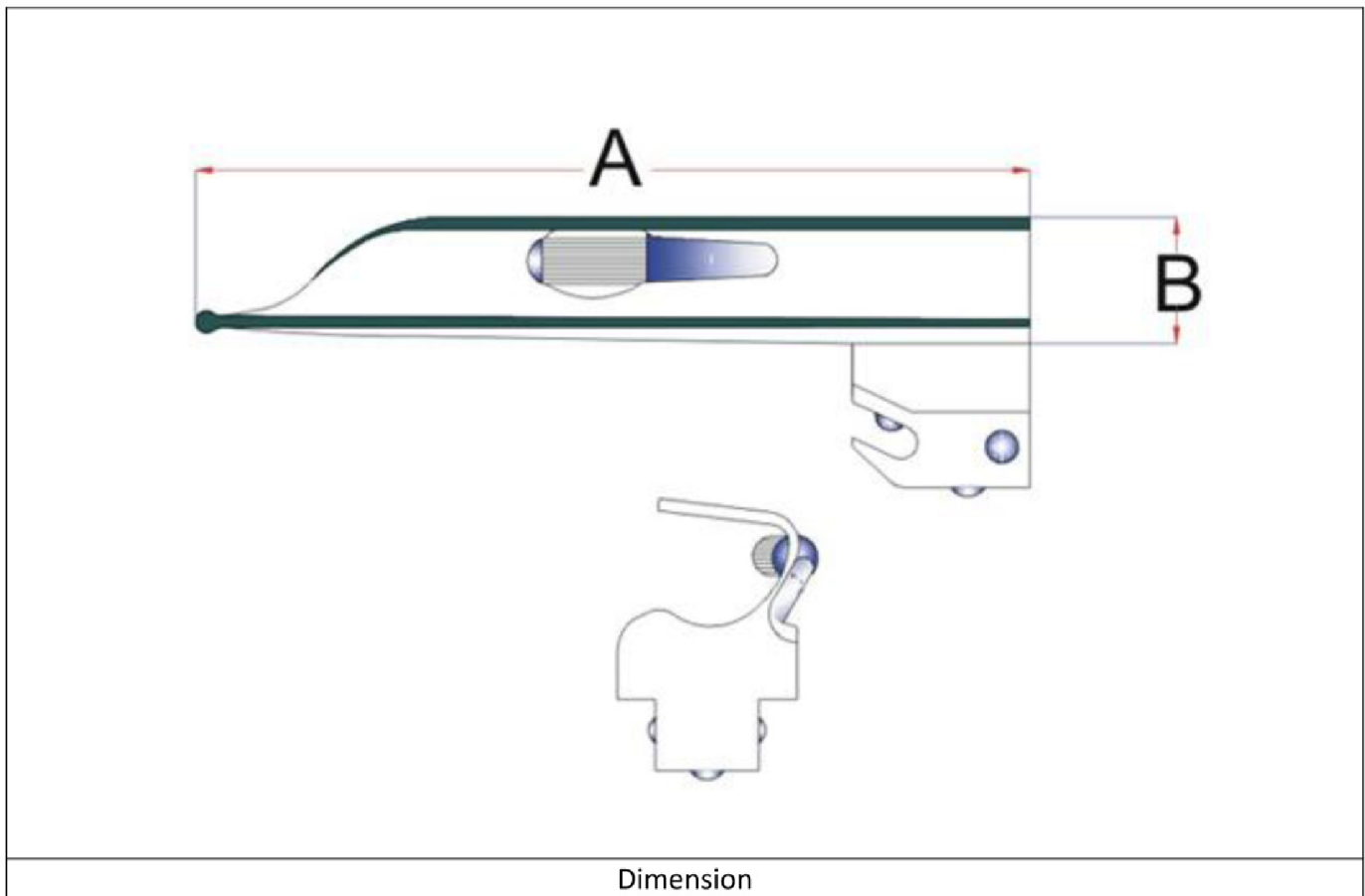
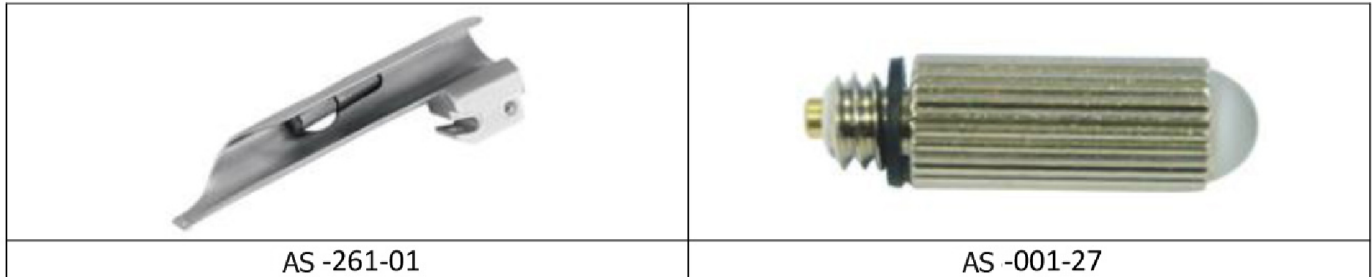

CAT#	SIZE	DESCRIPTION	A	B
AS -261-01	1	Infant	102mm	12mm





Battery Handles

CAT#	SIZE	DESCRIPTION	A	B
AS 110-EC-01	Small	Battery Handle 'AA'		
AS 111-EC-02	Medium	Battery Handle 'C'		
AS 112-EC-03	Large	Battery Handle 'D'		
AS 113-EC-04	Stubby	Battery Handle 'AA'		

	
AS 110-EC-01	AS 111-EC-02
	
AS 112-EC-03	AS 113-EC-04



Macintosh Polio

CAT#	SIZE	DESCRIPTION	A	B
810-251-03	3	Medium Adult	130mm	18mm

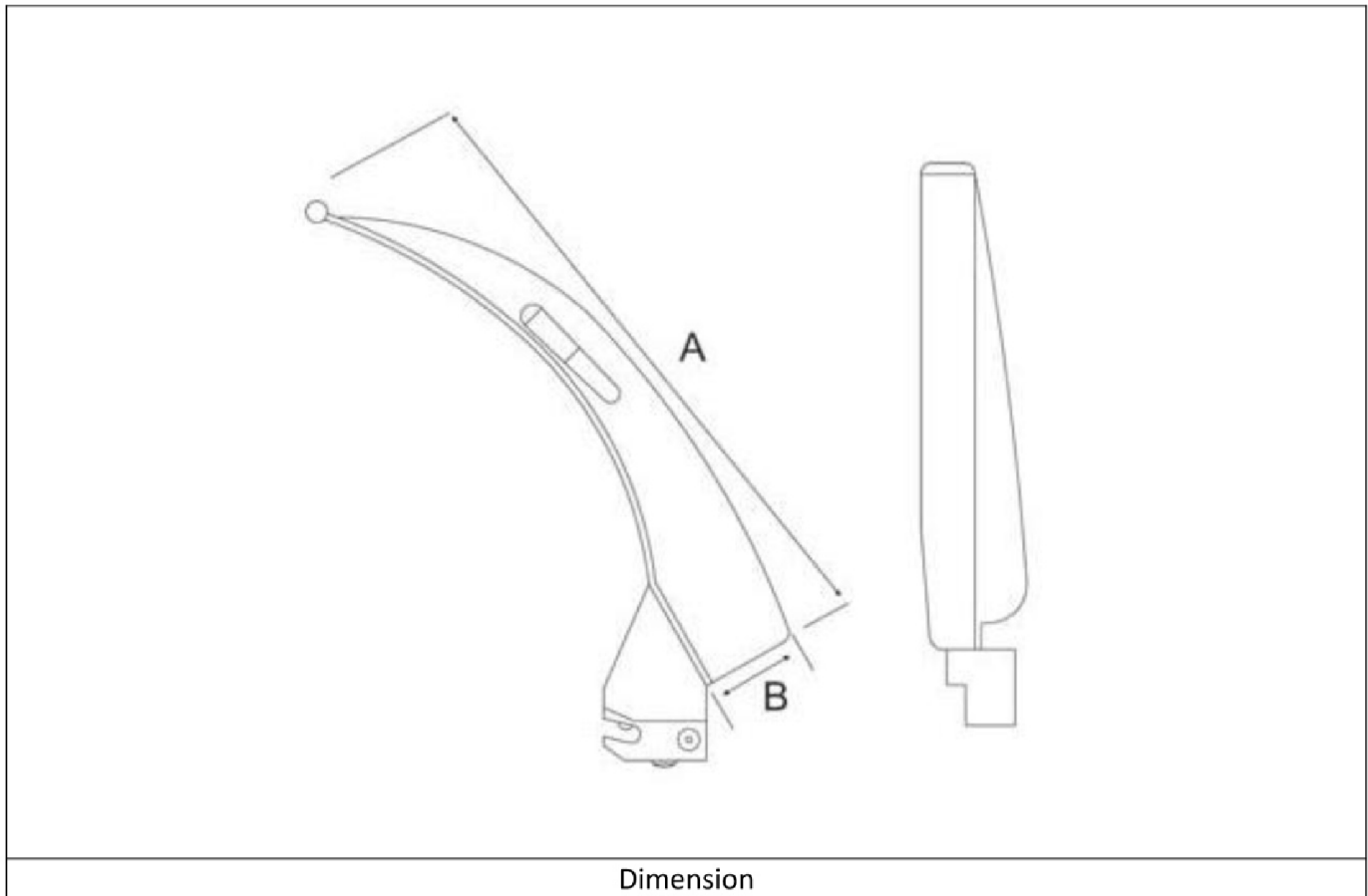
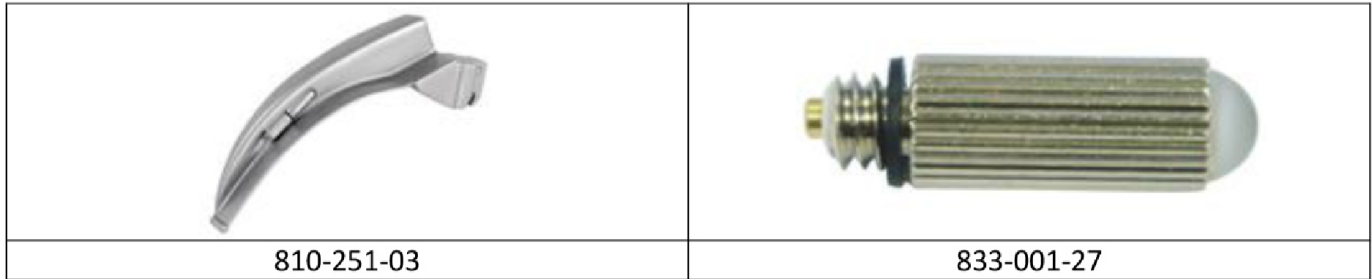



Sunflex Blades

CAT#	SIZE	DESCRIPTION	A	B
810-301-02	2	Sunflex EC-Mac	100mm	18mm
810-301-03	3	Sunflex EC-Mac	130mm	18mm
810-301-04	4	Sunflex EC-Mac	155mm	18mm

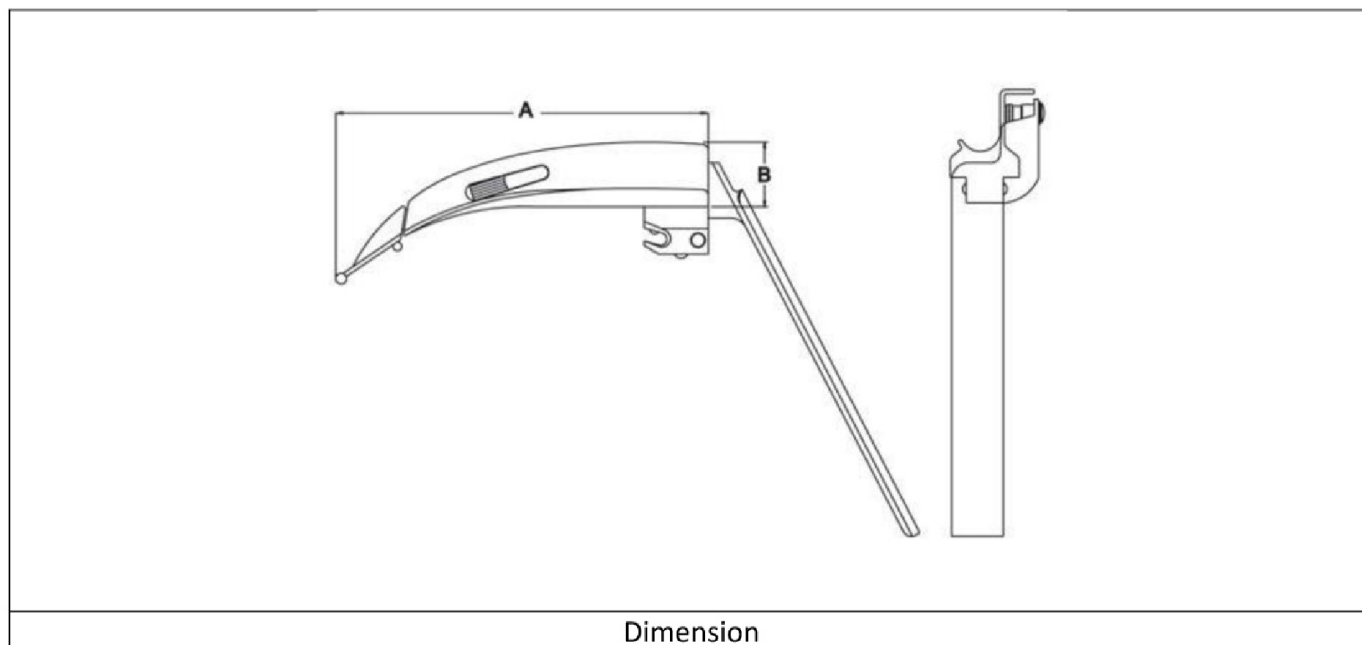

Macintosh (Fiber)

CAT#	SIZE	DESCRIPTION	A	B
810-021-00	0	Neonate	80mm	55mm
810-021-01	1	Infant	92mm	67mm
810-021-02	2	Child	100mm	75mm
810-021-03	3	Medium Adult	130mm	105mm
810-021-04	4	Large Adult	155mm	130mm
810-021-05	5	Large Adult	175mm	14mm

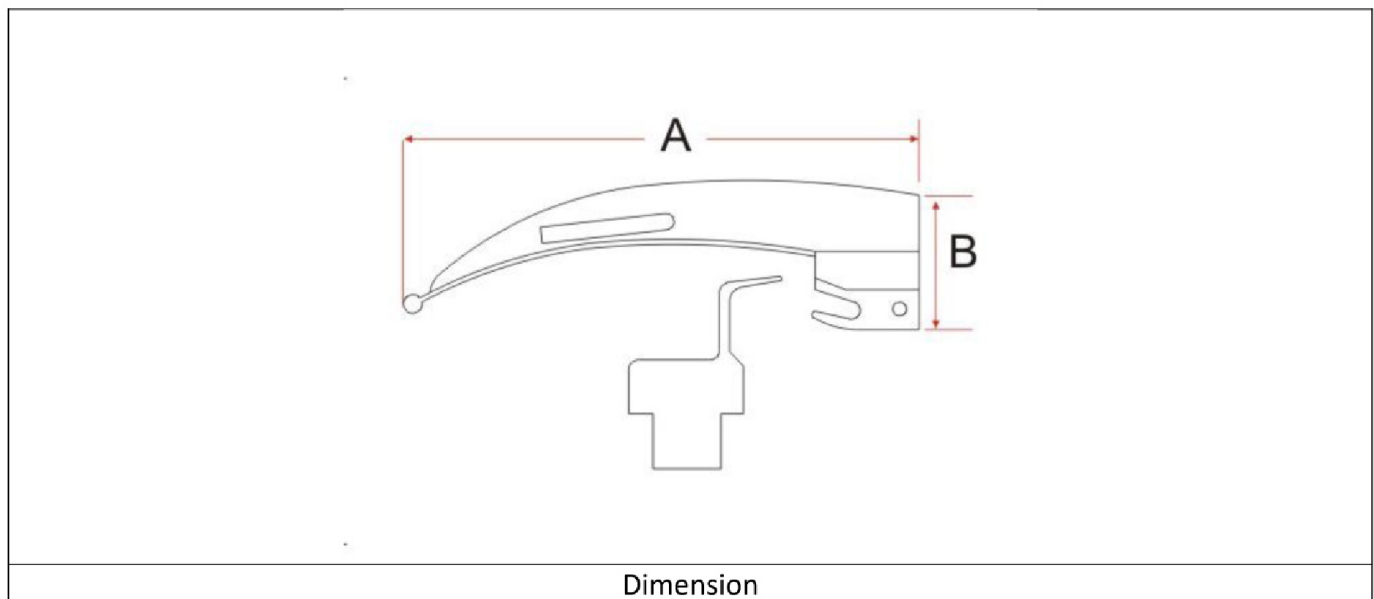
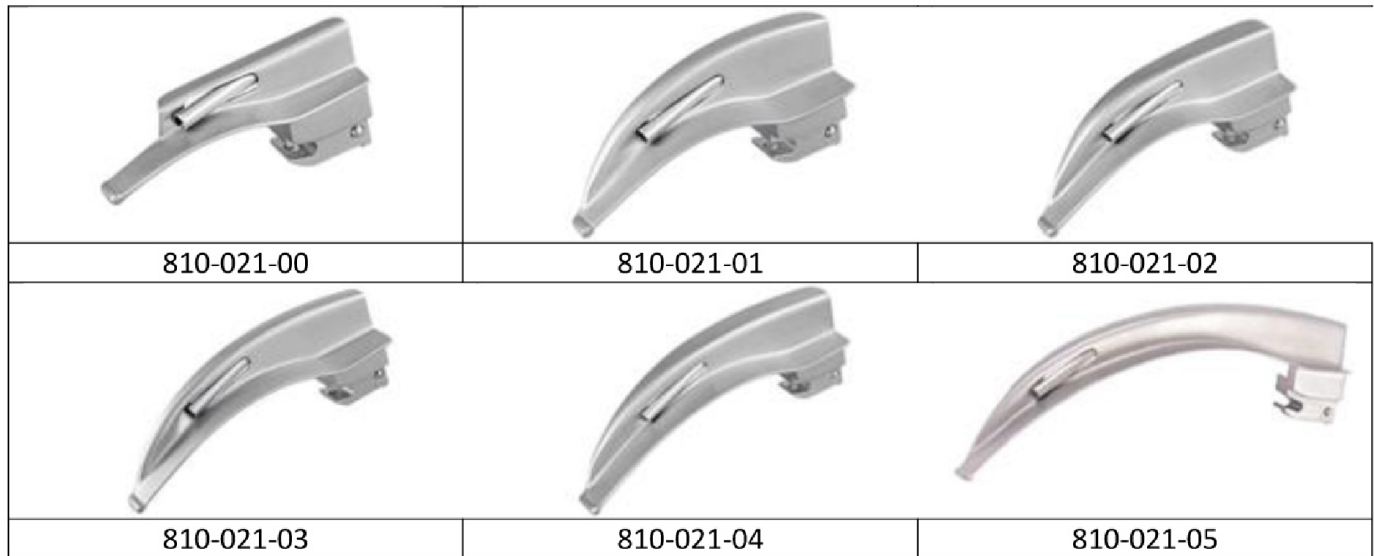



Miller (Fiber)

CAT#	SIZE	DESCRIPTION	A	B
810-031-00	0	Neonate	75mm	50mm
810-031-01	1	Infant	102mm	77mm
810-031-02	2	Child	153mm	128mm
810-031-03	3	Medium Adult	195mm	170mm
810-031-04	4	Large Adult	205mm	180mm
810-031-05	00	Premature	65mm	40mm

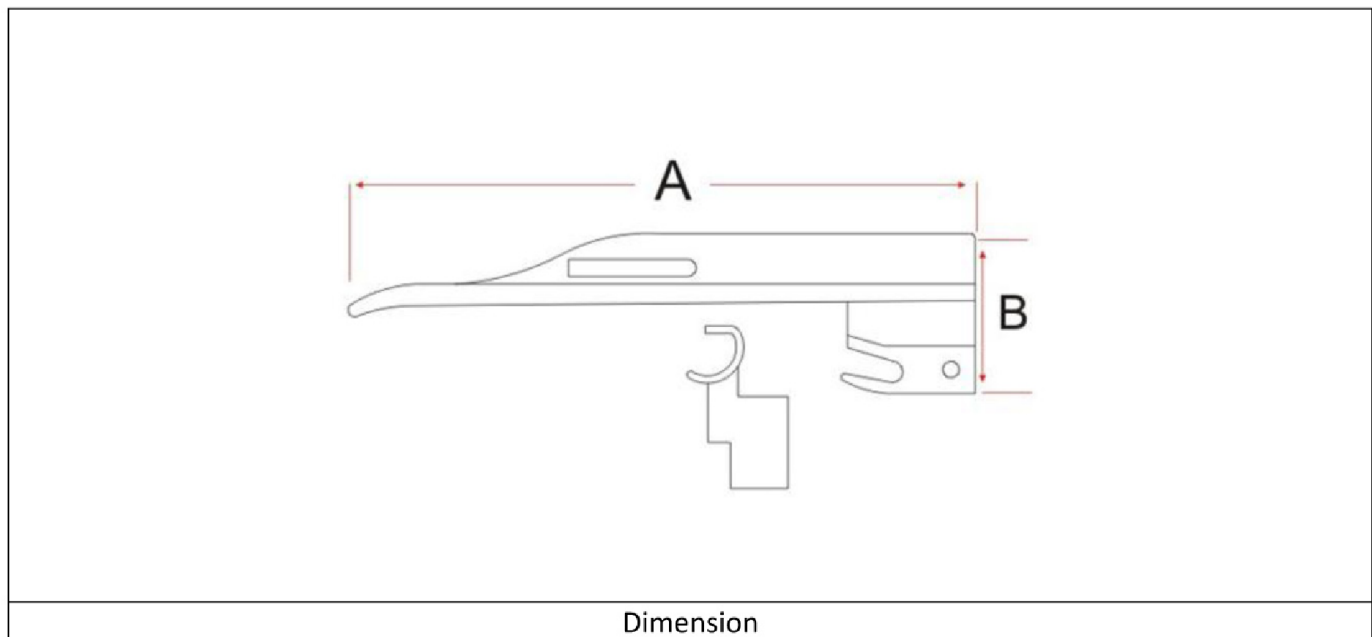

Wisconsin (Fiber)

CAT#	SIZE	DESCRIPTION	A	B
810-041-00	0	Neonate	76mm	51mm
810-041-01	1	Infant	102mm	77mm
810-041-02	2	Child	135mm	110mm
810-041-03	3	Medium Adult	162mm	137mm
810-041-04	4	Large Adult	199mm	174mm

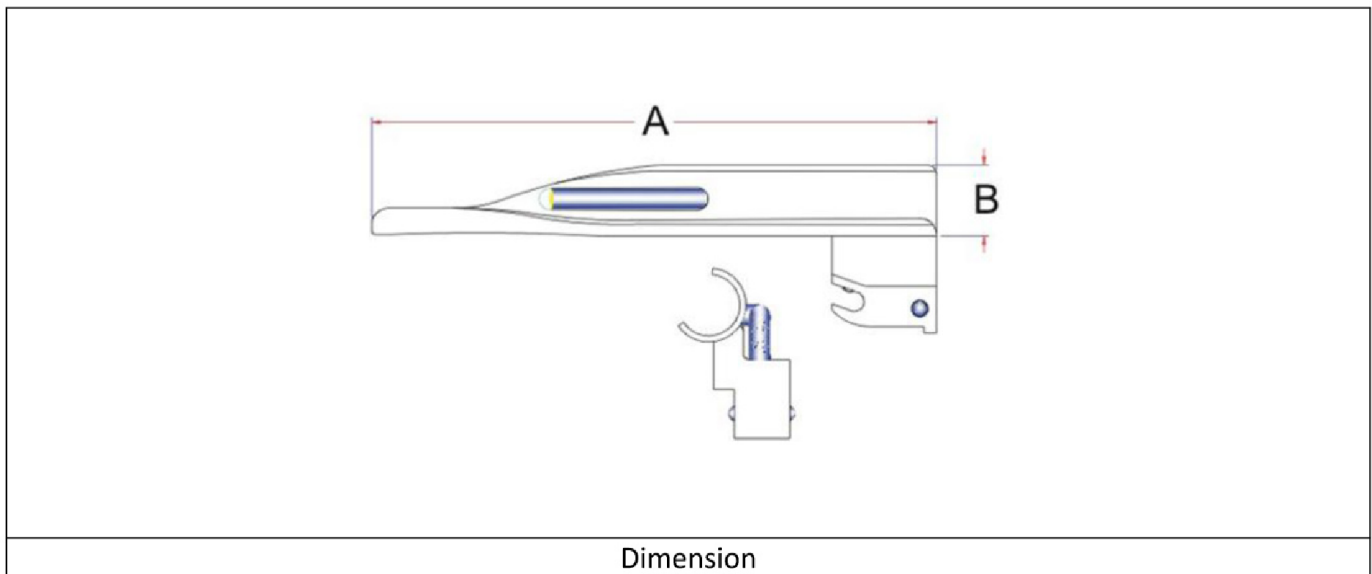
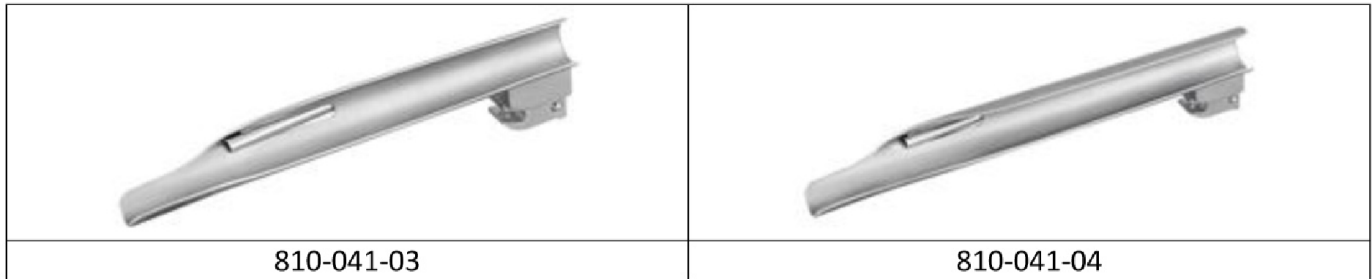



Polio Blades (Fiber)

CAT#	SIZE	DESCRIPTION	A	B
810-071-03	3	Angled 120°	130mm	105mm



810-071-03

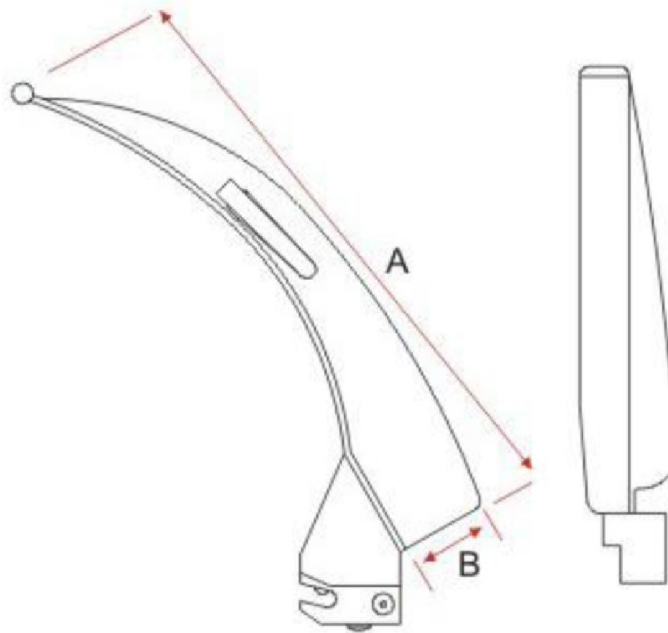

Dimension



AJMO STAR
SURGICO

Oxford (Fiber)

CAT#	SIZE	DESCRIPTION	A	B
810-081-01	1	Oxford Blade	102mm	77mm



810-081-01

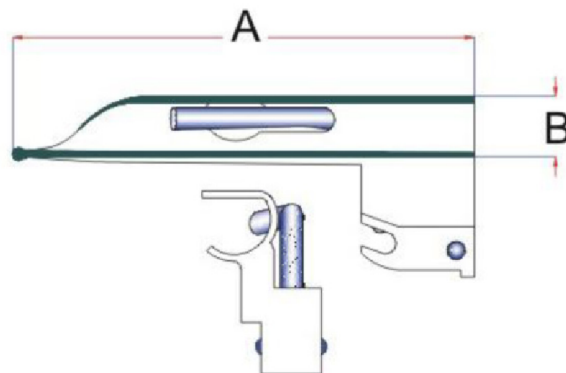

Dimension

F.O Battery Handles (Fiber)

CAT#	SIZE	DESCRIPTION	A	B
5510-EF-01	Small	Battery Handle 'AA'		
5511-EF-02	Medium	Battery Handle 'C'		
5512-EF-03	Large	Battery Handle 'D'		
5513-EF-04	Stubby	Battery Handle 'AA'		



5510-EF-01



5511-EF-02



5512-EF-03



5513-EF-04



Mill-Port (Fiber)

CAT#	SIZE	DESCRIPTION	A	B
810-110-00	0	Neonate	75mm	8.5mm
810-110-01	1	Infant	102mm	8.5mm

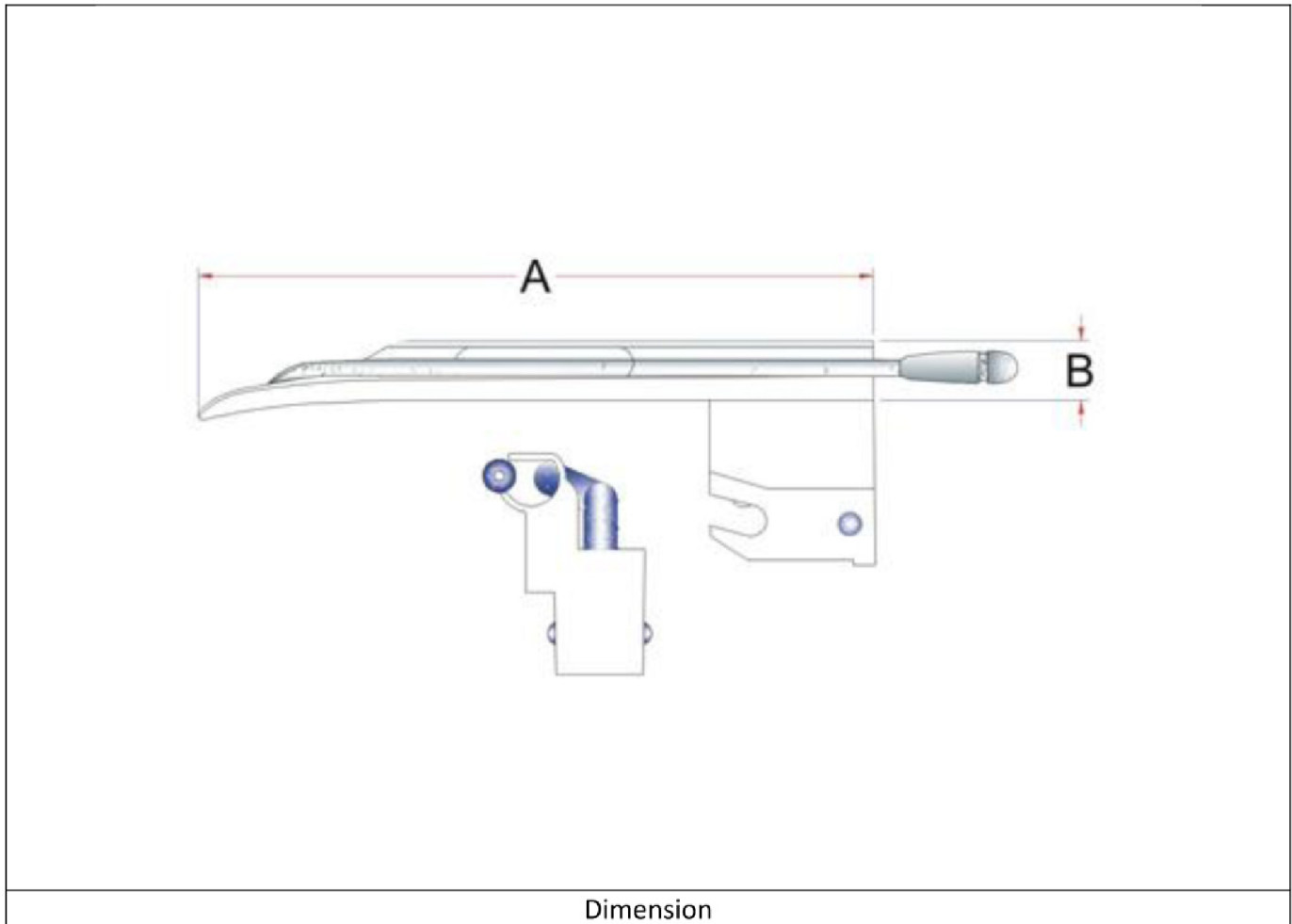
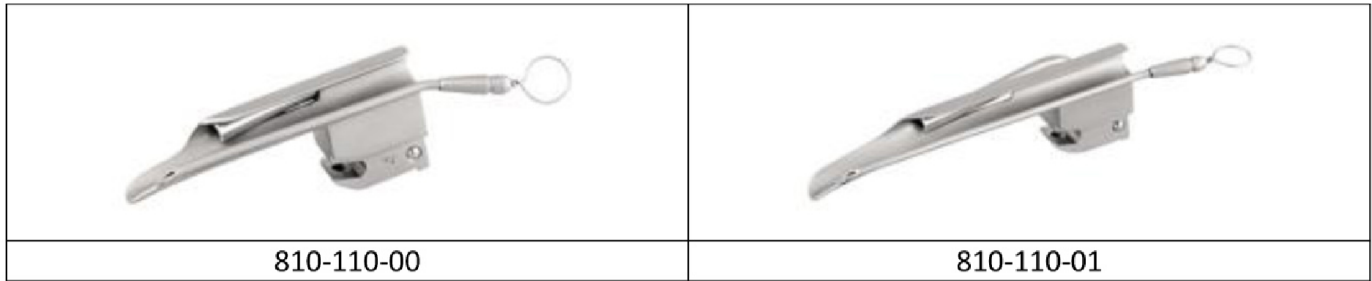

Macintosh IV Blade (Fiber)

CAT#	SIZE	DESCRIPTION	A	B
810-061-02	2	Child	100mm	21mm
810-061-03	3	Medium Adult	130mm	22mm
810-061-04	4	Large Adult	155mm	26mm

		
810-061-02	810-061-03	810-061-04

Maxlite Macintosh F.O Blade (Fiber)

CAT#	SIZE	DESCRIPTION	A	B
810-001-00	0	Neonate	80mm	13mm
810-001-01	1	Infant	92mm	14mm
810-001-02	2	Child	100mm	17mm
810-001-03	3	Medium Adult	130mm	18mm
810-001-03SC	3	"Strong Curve"	130mm	18mm
810-001-04	4	Large Adult	15mm	18mm

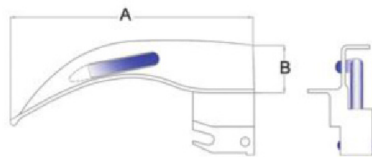

Dimension

Maxlite Miller F.O Blade (Fiber)

CAT#	SIZE	DESCRIPTION	A	B
810-011-00	00	Premature	76mm	12.5mm
810-011-01	0	Neonate	80mm	12.5mm
810-011-02	1	Infant	100mm	12.5mm
810-011-03	2	Child	152mm	14.5mm
810-011-04	3	Medium Adult	192mm	15mm
810-011-05	4	Large Adult	207mm	17mm

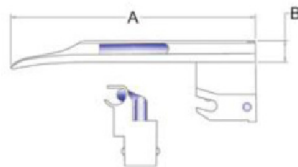

Dimension

Greenine Sunflex Blades (Fiber)

CAT#	SIZE	DESCRIPTION	A	B
810-120-02	2	Greenine Sunflex Blades	100mm	78mm
810-120-03	3	Greenine Sunflex Blades	130mm	108mm
810-120-04	4	Greenine Sunflex Blades	155mm	133mm

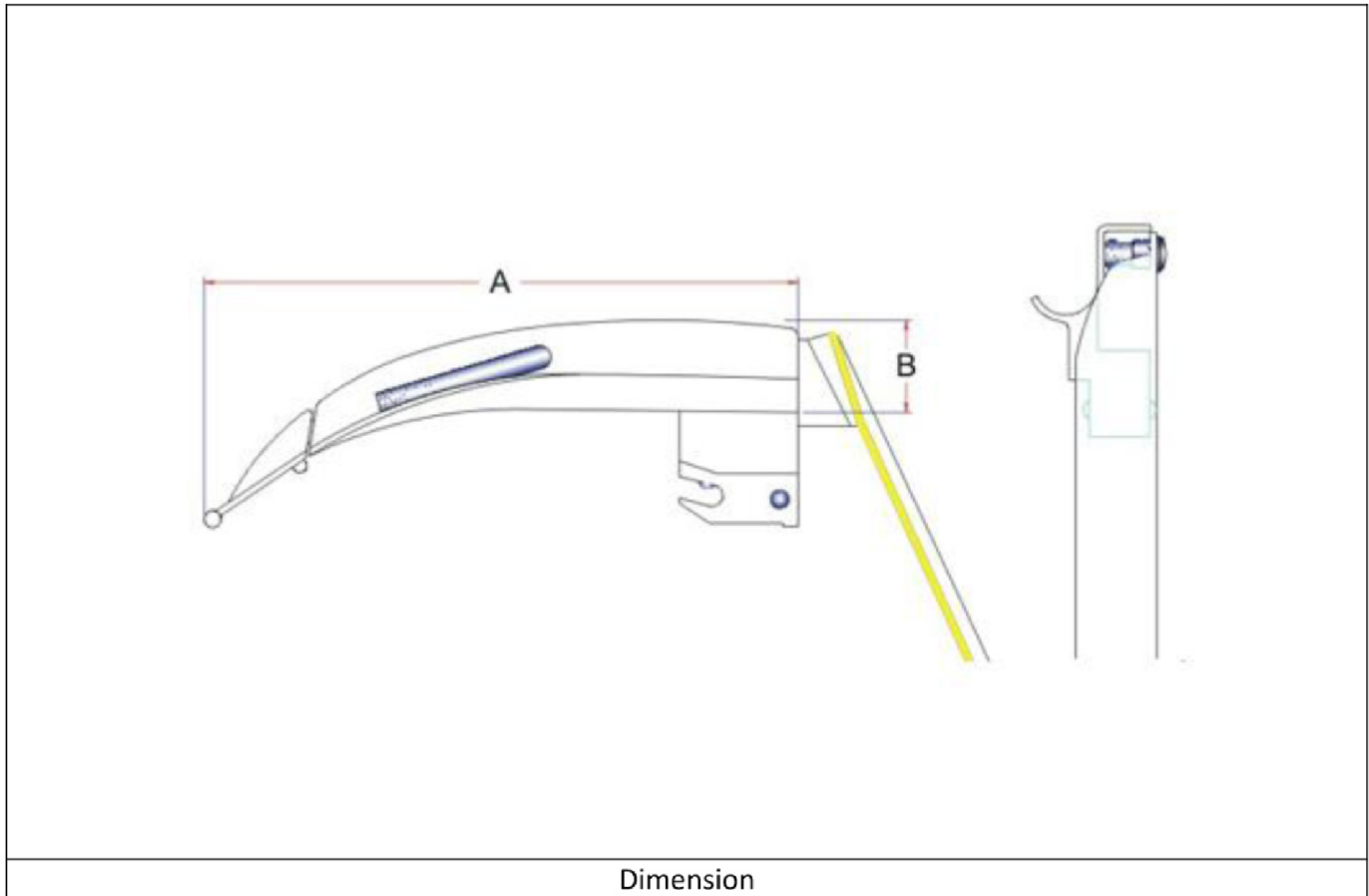



Mac Blades (Disposables)

CAT#	SIZE	DESCRIPTION	A	B
3501-DF-01	1	Lunalite D Mac Blades		
3502-DF-02	2	Lunalite D Mac Blades		
3503-DF-03	3	Lunalite D Mac Blades		
3504-DF-04	4	Lunalite D Mac Blades		



3501-DF-01



3502-DF-02



3503-DF-03



3504-DF-04

Dermatoscope

Products Details

Features

LED light or German 2.5V halogen light
10X optic system
Retiela contact plate
Easy to focus, with large focus ring
Fully portable with its pouch

Size

45-1 Medium 2x C size batteries
45-2 Mini 2x AA size batteries

Options

Private labels and OEM designs are accepted.





Diagnostic Sets

Products Details

Features

Products Include:

Otoscope
Ophthalmoscope
Spreadable Nasal Speculum
Bent Arm Illuminator
Tongue Depressor
Tongue Blade Holder
Laryngeal Mirrors
Medium Battery Handle
Ear Tips
Supplied with Halogen bulb or LED bulb,
please confirm while ordering

Size

29-1 Fibre Optic Diagnostic set
29-2 Conventional Diagnostic set

Options

Private label and OEM designs are accepted.



Esophagoscope

Products Details

Size

52-01 Small 26 cm, 3mm dia fiber optic
52-02 Medium 30 cm, 3mm dia fiber optic
52-03 Large 43 cm, 5mm dia fiber optic

Options

Private label and OEM designs of
Endoscopes are accepted.





AJMO STAR
SURGICO

CONTACT US



AJMO STAR SURGICO

Sahowali (East) P.O. Cantt

Sialkot-51310, Pakistan

Ph: 0092 52 353104

Fax: 0092 52 353096

E-mail: sales@ajmostar.com

E-mail: info@ajmostar.com

Url: www.ajmostar.com